



# Goodyear Truck Tyres

---

**Technical Data Book**

---

**Innovation**

- Tyre Range and Application Map
- Technical Data
- regrooving Guidelines
- Tyre Technology





































---

# Contents

---

<b>Truck Tyre Range and Application Map</b>	4
<b>Tyre Range</b>	6
Marathon	8
Regional	12
Omnitrac	18
Offroad	22
Urban	24
UltraGrip	26
<b>Technical Data</b>	28
<b>Regrooving Guidelines</b>	38
Regrooving Guidelines	40
Marathon	42
Regional	44
Omnitrac	46
Offroad	47
Urban	48
UltraGrip	49
<b>Tyre Technology</b>	50
Tyre construction	52
Tyre terminology	53
Tyre markings	54
Load index and speed symbol	56
Interaction of load and speed	57
Rim and wheels	60
Tubes and flaps	62
Valves	64
Manufacturing process	66

# Truck Tyre Range and Application Map

	Steer	Drive	Trailer
<b>Marathon</b> 	LHS II LHS II 65, 55 and 50 series 	LHD II 	LHT+ 435/50R19.5 LHT / LHT+ 65 and 55 series 
	LHS LR8 	LHD 495/45R22.5 LHD II 265/55R19 	LHT+ 455/40R22.5 LHT (LPT) LHT 265/55R19 
<b>Regional</b> 	RHS II 	RHD II 	RHT 
	RHS II 17.5 and 19.5 	RHD II 17.5 and 19.5 	RHT (LPT) 
<b>Omnitrac</b> 	MSS 		
	MSS 75 and 90 series 	MSD 	MST 
<b>Offroad</b> 	MSS 	ORD 	
		ORD 14.00R20 ORD 90 and 85 series 	MST 
<b>Urban</b>  	UrbanMax MCA 	UrbanMax MCD Traction 	
		MCD Super Single 	
<b>UltraGrip</b> 	WTS 5-rib WTS 6-rib 	WTD 	

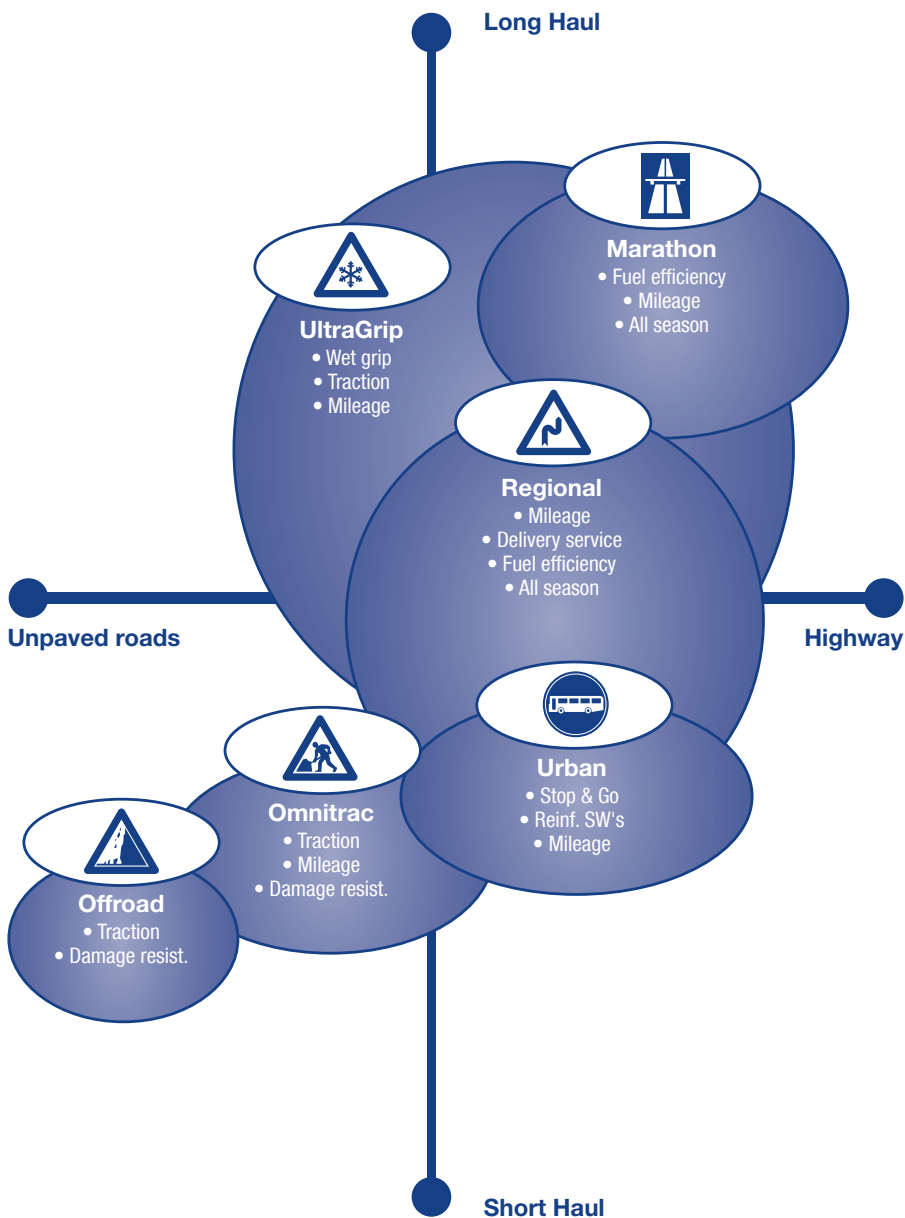

# Tyre Range





# Marathon LHS II



A new generation steer axle tyre specifically designed for long haul operations featuring “Fuel Max” technology.

The combination of lowest rolling resistance with excellent mileage performance and superb wet braking characteristics make the new LHS II an ideal fitment for today’s demanding long haul transport operations.



- Wide tread, 5 rib layout (6 rib for 65, 55 and 50 series) for excellent mileage, even wear and good handling/stability
- “Flexomatic Blades” and “Edge Blading” on grooves for superb braking on wet, even wear and high mileage
- Latest technology carcass geometry and materials for enhanced damage resistance, durability and retreadability

## Technical Data



Size	Load Index	Speed Symbol
315/80R22.5	156/150 (154/150)	L (M)
295/80R22.5	152/148	M
315/70R22.5	154/150 (152/148)	L (M)
305/70R22.5	152/148 (150/148)	L (M)
275/70R22.5	148/145	M
385/65R22.5	160 (158)	K (L)

Size	Load Index	Speed Symbol
315/60R22.5	152/148	L
295/60R22.5	150/147 (149/146)	K (L)
385/55R22.5	160 (158)	K (L)
375/50R22.5	156	K
355/50R22.5	154 (152)	K (L)

# Marathon LHS LR8



Specifically designed for usage in hot countries, the LHS LR8 pattern provides high mileage combined with high steering precision and driver comfort. The dedicated carcass construction and tread compound suit the demanding requirements of the severe service requirements in hot country areas (e.g, Middle East and Africa).



- Even load distribution for reduced tyre wear
- Low rolling resistance for added fuel savings
- Low rolling noise
- Excellent steering characteristics and wet braking performance
- Increased number of kilometres per tyre:  
improved steering stability and driving comfort

## Technical Data



Size	Load Index	Speed Symbol
315/80R22.5	156/150 (154/150)	L (M)
295/80R22.5	152/148	M

Size	Load Index	Speed Symbol
12R22.5	152/148	L
11R22.5	148/145	M



# Marathon LHD II



A new generation drive axle tyre specifically designed for long haul operations featuring “Fuel Max” technology.

The combination of lowest rolling resistance with excellent mileage performance and superb wet braking characteristics make the new LHD II an ideal fitment for today’s demanding long haul transport operations.



- Wide tread, directional design, with large shoulder ribs for excellent mileage, traction and braking as well as even wear pattern
- “3D-BIS” waffle blade technology for optimum traction and braking performance and improved handling and stability
- Latest technology carcass geometry and materials for enhanced damage resistance, durability and retreadability

## Technical Data



Size	Load Index	Speed Symbol	Size	Load Index	Speed Symbol
315/80R22.5	156/150 (154/150)	L (M)	315/60R22.5	152/148	L
295/80R22.5	152/148	M	295/60R22.5	150/147 (149/146)	K (L)
315/70R22.5	154/150 (152/148)	L (M)	295/55R22.5	147/145	K
305/70R22.5	152/148 (150/148)	L (M)	265/55R19.5*	136/134	M
275/70R22.5	148/145	M			

\* Different pattern

# Marathon LHD Super Single Drive



Goodyear's Super Single drive tyre for long haul applications. An alternative to dual mounted 315/70R22.5 assemblies providing significant improvements in rolling resistance combined with increased payload and 35% less disposal material.

The 495/45R22.5 being regroovable and retreadable, it contributes to the fleet's economical and ecological efficiency.



- Replaces dual mounted 315/70R22.5 on drive axles
- Weight savings up to 110 kg - increased payload
- Rolling resistance improved by 17% - leading to substantial fuel savings
- 35% less disposable rubber - environmentally friendly
- Vehicle track width increased by 34 cm for improved stability and handling
- Compatible with on-board pressure monitoring systems

## Technical Data



Size	Load Index	Speed Symbol	Size	Load Index	Speed Symbol
495/45R22.5	169	K			

# Marathon LHT+ 435/50R19.5



Goodyear “Megatrailer” tyre 435/50R19.5 has been further improved in terms of potential fuel savings. A new, low rolling resistance tread compound on the LHT+ results in better fuel efficiency without any compromise on tire mileage, for enhanced cost per km performance.

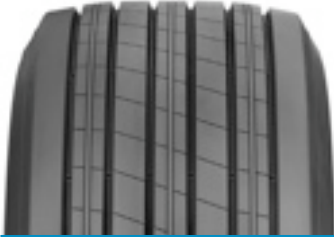

- Low rolling resistance, good fuel efficiency
- High mileage, even wear, low noise
- Superb braking on wet
- Robust carcass, regroovable and retreadable

## Technical Data



Size	Load Index	Speed Symbol	Size	Load Index	Speed Symbol
435/50R19.5	160	J			

# Marathon LHT+ 455/40R22.5



The Goodyear Marathon LHT+ 455/40R22.5 is a “first in industry” 40 series long haul trailer tyre combining low outside diameter with 22.5” wheels and 9 ton axle load capacity. These features allow maximum loading capacity and use of 22.5” braking systems while providing improved mileage performance in long haul operations.



- Low outside diameter for optimum loading volume
- 22.5” wheels allowing use of bigger brakes for reduced maintenance cost
- 9 ton axle load capacity
- High mileage thanks to wide tread

## Technical Data



Size	Load Index	Speed Symbol	Size	Load Index	Speed Symbol
455/40R22.5	160	J			

# Marathon LHT / LHT+



The Goodyear Marathon LHT low aspect ratio range has been specifically developed for long haul trailer use. Small diameters allow high volume transportation while wide treads, with optimised compounds, provide maximum mileage and low fuel consumption. 385/55R22.5 LHT+ now features an improved tread compound, for further improved fuel efficiency.



- Wide tread with high net to gross for maximum mileage
- Low rolling resistance
- Optimised bead area construction for better durability
- High load carrying capacity (up to 10 tons/axle - 435/50R22.5)
- Size range covering various platform heights

## Technical Data



Size	Load Index	Speed Symbol	Size	Load Index	Speed Symbol
385/65R22.5	160 (158)	K (L)	435/50R22.5	164	J
385/55R22.5*	160 (158)	K (L)			

\* LHT+ , new low RR tread compound

# Marathon LHT Low Platform Trailer



The Goodyear Marathon LHT is the new low platform trailer tyre from Goodyear with significantly improved wet braking, fuel economy and mileage performance. These advances, made possible by the latest compound technology and tread design, have also reduced road-noise levels.



- Better rolling resistance delivering improved fuel economy
- More mileage and greater lateral stability
- Even wear profile and balanced pressure distribution
- Resistant to stones, excellent braking and skid resistance in the wet

## Technical Data



Size	Load Index	Speed Symbol	Size	Load Index	Speed Symbol
285/70R19.5	150/148	J	245/70R17.5	143/141 (146/144)	J (F)
265/70R19.5	143/141	J	205/65R17.5	129/127 (130/130)	J (F)
245/70R19.5	141/140	J	265/55R19.5*	141/140	J
235/75R17.5	143/141 (144/144)	J (F)	11R22.5	148/145 (146/143)	J (L)
215/75R17.5	135/133	J	9.5R17.5	143/141	J

\* Different pattern

# Regional RHS II 22.5



A new generation regional haul steer tyre coping with the demanding requirements of modern regional haul service, optimised for high mileage and a wide application range.

The combination of a specifically developed tread pattern with an innovative high silica content tread compound results in excellent mileage performance, optimum wet braking, even wear and low rolling resistance.

Additionally, the optimised cavity geometry and the use of latest technology carcass and reinforcement materials (super tensile wire cords) provide the Regional RHS II with superior durability and damage resistance.



- Wide tread, 5 rib pattern, groove edge blading, for excellent mileage, even wear and superb handling and stability
- High density, flexomatic blading, for outstanding braking on wet surfaces combined with high mileage
- New technology, high silica tread compound, for optimum mileage combined with low rolling resistance, good tear and damage resistance

## Technical Data



Size	Load Index	Speed Symbol
315/80R22.5	156/150 (154/150)	L (M)
295/80R22.5	152/148	M
315/70R22.5	154/150 (152/148)	L (M)
305/70R22.5	152/148 (150/148)	L (M)
275/70R22.5	148/145	M
385/65R22.5	160 (158)	K (L)

Size	Load Index	Speed Symbol
315/60R22.5	152/148	L
295/60R22.5*	150/147 (149/146)	K (L)
13R22.5	156/150 (154/150)	L (M)
12R22.2	152/148	L
11R22.5	148/145	L

\* in preparation



# Regional RHS II 17.5 and 19.5



A new generation of 17.5" and 19.5" steer tyres, featuring KMax Technology - a combination of latest technology design and construction features.

The wide, 5 rib tread pattern, with high density flexomatic blading results in excellent mileage performance, good handling and stability as well as superb braking on wet. Latest technology tread compounds, carcass and belt materials and an optimized bead geometry assure good durability and retreadability of the this new generation steer tyres.

RHS II in 17.5" & 19.5" size tyres is developed for a wide application range, covering today's multiple service types in regional and distribution operations.



- Wide, 5 rib tread pattern for high mileage, good handling and even wear
- Flexomatic blading on center ribs, for improved braking on wet and mileage
- Rib edge blading on outer grooves result in even wear pattern and better wet braking
- Specifically developed groove geometries result in minimized stone holding and better durability
- Latest technology carcass geometry, materials and an optimized bead construction - for improved durability and damage resistance

## Technical Data



Size	Load Index	Speed Symbol
205/75R17.5	124/122	M
215/75R17.5	126/124	M
225/75R17.5	129/127	M
235/75R17.5	132/130	M
245/70R17.5	136/134	M
265/70R17.5	139/136	M

Size	Load Index	Speed Symbol
9.5R17.5	129/127	M
245/70R19.5	136/134	M
265/70R19.5	140/138	M
285/70R19.5	146/144(144/142)	M (L)
305/70R19.5	148/145	M



# Regional RHD II 22.5



A new generation regional haul drive tyre coping with the demanding requirements of modern regional haul service. The tyre is optimised for high mileage and a wide application range and features KMax Technology developed to maximise mileage performances without compromising other tyre characteristics.

Goodyear's new generation regional drive tyre suits the need for a wide range of applications as today's fleets require maximum flexibility to operate on pure regional and/or in combined regional/long haul service.



- Wide tread, 5 rib directional pattern, for excellent mileage, even wear and superb handling and stability
- Special, directional groove tapers, highly bladed pattern, for improved wet braking and mileage performances, excellent traction and winter grip
- New technology, high silica tread compound, for optimum mileage combined with low rolling resistance, good tear and damage resistance and excellent braking on wet
- Optimised carcass geometry, latest technology carcass materials resulting in enhanced robustness, durability and retreadability

## Technical Data



Size	Load Index	Speed Symbol
315/80R22.5	156/150 (154/150)	L (M)
295/80R22.5	152/148	M
315/70R22.5	154/150 (152/148)	L (M)
305/70R22.5	152/148 (150/148)	L (M)
275/70R22.5	148/145	M

Size	Load Index	Speed Symbol
13R22.5	156/150 (154/150)	L (M)
12R22.2	152/148	L
11R22.5	148/145	L
315/60R22.5	152/148	L
295/60R22.5*	150/147 (149/146)	K (L)

\* in preparation



# Regional RHD II 17.5 and 19.5



A new generation of 17.5" and 19.5" drive tyres, featuring KMax Technology - a combination of latest technology design and construction features.

The wide tread pattern, featuring a high net to gross center area, with 3D BIS blading, results in high mileage combined to good all season traction performances and even wear type.

Latest technology tread compounds, carcass and belt materials and an optimized bead geometry assure good durability and retreadability of this new generation drive tyres.

RHD II in 17.5" & 19.5" size tyres is developed for a wide application range, covering today's multiple service types in regional and distribution operation.



- A wide tread pattern with high net-to-gross area, resulting in excellent mileage, good handling and even wear type.
- The high density blading combined to the specific block distribution in the center ribs results in excellent traction performance and all season capabilities.
- Latest technology 3D BIS blades for improved traction and braking on wet and wintery roads.
- Specifically designed groove geometries to reduce stone holding
- Latest technology carcass geometry, materials and an optimized bead construction - for improved durability and damage resistance.

## Technical Data



Size	Load Index	Speed Symbol
205/75R17.5	124/122	M
215/75R17.5	126/124	M
225/75R17.5	129/127	M
235/75R17.5	132/130	M
245/70R17.5	136/134	M
265/70R17.5	139/136	M

Size	Load Index	Speed Symbol
9.5R17.5	129/127	M
245/70R19.5	136/134	M
265/70R19.5	140/138	M
285/70R19.5	146/144(144/142)	M (L)
305/70R19.5	148/145	M



# Regional RHT

The Goodyear Regional RHT 22.5" trailer tyre features a high wearable rubber volume. In addition, the tread compound is specifically developed for superb damage resistance on the demanding regional haul services.



- High mileage
- Damage resistant tread
- Good durability and retreadability
- Reduced stone holding
- Robust carcass construction

## Technical Data



Size	Load Index	Speed Symbol	Size	Load Index	Speed Symbol
445/65R22.5	165	K	385/65R22.5	160 (158)	K (L)
425/65R22.5	169	K	385/55R22.5	160 (158)	K (L)

# Regional RHT Low Platform Trailer

The Goodyear Regional RHT is the new tyre for low platform trailer applications in regional service. Specifically designed for optimum mileage performance combined with robust, durable construction for high load carrying capacity and damage resistance.



- Low rolling resistance delivering improved fuel economy
- More mileage and greater lateral stability
- Durable, easily retreaded
- Even wear profile and balanced pressure distribution
- Resistant to stones, excellent braking and skid resistance in the wet

## Technical Data



Size	Load Index	Speed Symbol	Size	Load Index	Speed Symbol
8.25R15TT	143/141	J	7.50R15TT	135/133	K





# Omnitrac MSS



The Goodyear Omnitrac MSS tyre for steering axles provides excellent mileage while featuring damage resistant tread patterns. Latest compound technology as well as ECD technology in view of optimised durability and retreadability are integrated in this mixed service steer tyre.

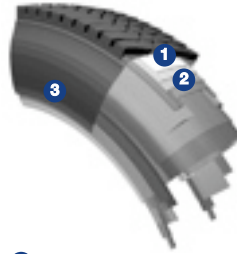

- 1 Corrosion-resistant layer
- 2 High-strength steel belts
- 3 Reinforced side walls



- High mileage
- Road handling and lateral stability
- Developed for the toughest service conditions
- Good damage resistance
- Even wear profile
- Traction and wet skid resistance
- Maximised stone penetration protection

## Technical Data



Size	Load Index	Speed Symbol	Size	Load Index	Speed Symbol
315/80R22.5	156/150	K	13R22.5	156/150	K
295/80R22.5	152/148	K *	12R22.5	152/148	K
275/70R22.5	148/145	K	11R22.5	148/145	K
265/70R19.5	143/141 (140/138)	J (L)	12.00R24TT & TL	160/156	K
385/65R22.5	160 (158)	K (L) *	12.00R20TT	154/150	K

\* 5-rib



# Omnitrac MSS 445/75R22.5 and 375/90R22.5



The Goodyear Omnitrac MSS 445/75R22.5 and 375/90R22.5 are especially designed for high load vehicles in mixed service and on-road applications.



- Optimum tear- and wear-resistance
- Added protection against cuts, chipping and chunking
- Excellent traction, handling
- Maximised cargo payload and flotation characteristics

## Technical Data



Size	Load Index	Speed Symbol	Size	Load Index	Speed Symbol
445/75R22.5	170	J	375/90R22.5	164/160	G

# Omnitrac MSD



The Goodyear Omnitrac MSD drive tyre features 'ECD technology inside'. ECD technology comprises: corrosion-resistant barrier of specially developed steel cords shielding the high-strength steel belts from penetration damage, while preventing moisture from entering the carcass.



- Even load distribution for reduced tyre wear
- On/off-road traction
- Optimum self-cleaning characteristics
- Excellent resistance to damage
- Increased durability and retreadability

## Technical Data



Size	Load Index	Speed Symbol	Size	Load Index	Speed Symbol
375/90R22.5	164/160	G	12R22.5	152/148	K
315/80R22.5	156/150	K	12.00R24TT & TL	160/156	K
295/80R22.5	152/148	K	12.00R20TT	154/150	K
13R22.5	156/150	K			

# Duraseal (Omnitrac MSS and MSD)



Goodyear's patented "DuraSeal Technology" - the tyre that repairs itself. A built-in layer of sealant material seals punctures up to a diameter of 6mm in the tyre crown area, allowing the vehicle to continue running without pressure loss and with no effects on other tyre performances. Ideal for mixed service applications (e.g. construction vehicles, concrete mixers, waste disposal vehicles) to minimise vehicle downtime risk and thereby improving your fleet's efficiency.



- Seals crown area punctures up to 6mm diameter
- Sealing properties are retained throughout tyre life, even after retreading - for maximum efficiency
- Punctures can be repaired at retread stage for continuous sealing properties

"DuraSeal" tyres are available in Omnitrac MSS and MSD patterns

## Technical Data



Size	Load Index	Speed Symbol	Size	Load Index	Speed Symbol
315/80R22.5	156/150	K	13R22.5	156/150	K
385/65R22.5	160 (158)	K (L)			

# Omnitrac MST



The Goodyear Omnitrac MST 'Super Single' tyre for trailer axles gives exceptional mileage thanks to Goodyear's new, high wear- and tear-resistance mixed-service tread compound.



- High mileage, increased resistance to cuts, chipping and chunking
- Self-cleaning
- Excellent traction and resistance to chunking
- Reduced road-noise
- Ensures even shoulder wear
- Increased durability and retreadability

## Technical Data



Size	Load Index	Speed Symbol	Size	Load Index	Speed Symbol
445/65R22.5	169	K	385/65R22.5	160 (158)	K (L)



# Offroad ORD



The Goodyear Offroad ORD drive tyre features 'ECD technology inside'. ECD technology comprises: a corrosion-resistant specially developed steel cords shielding the high-strength steel belts from penetration damage, while preventing moisture from entering the carcass; sturdy, impact-resistance carcass and sidewalls give extra protection against lateral impacts.



- Secure off-road traction and high mileage
- Exceptional resistance to tearing and cutting
- Excellent resistance to stone holding and self-cleaning ability
- Optimum durability and retreadability through ECD technology

## Technical Data



Size	Load Index	Speed Symbol	Size	Load Index	Speed Symbol
13R22.5	156/150	G	12.00R24	160/156	G
12R22.5	152/148	J	12.00R20	154/150	G

# Offroad ORD 375/90R22.5 and 365/85R20

Originally developed for special military, airport fire brigade and road maintenance applications, the Goodyear Offroad ORD gives excellent off-road traction, stone holding resistance and balanced wear around the circumference.



- Optimum durability and retreadability
- Exceptional off-road traction and cutting resistance
- Resistance to tearing and cutting for more kilometres
- Self-cleaning to avoid stone holding and increase traction

## Technical Data



Size	Load Index	Speed Symbol	Size	Load Index	Speed Symbol
375/90R22.5	164/160	G	365/85R20	164	J

# Offroad ORD 14.00R20

The Goodyear Offroad ORD 14.00R20 is a specific tyre for off-road applications, mountable on all positions.

Optimised for military and all wheel driven vehicles. Provides excellent damage resistance and traction properties even on soft or sandy surfaces.



- Robust, damage resistance construction
- Excellent off-road traction and chipping/chunking resistance
- Optimised self-cleaning properties
- Low noise
- All position usage possible

## Technical Data



Size	Load Index	Speed Symbol	Size	Load Index	Speed Symbol
14.00R20	164/160	G			



# UrbanMax MCA



The new MCA municipal tyre, featuring UrbanMax Technology, a combination of latest technology tread pattern and state of the art materials. UrbanMax MCA tyres are specifically developed to provide excellent mileage in “stop & go” applications. In addition it provides good braking and traction on wet. MCA tyres are usable as steer or as all position tyres on municipal vehicles. All season use possible (M+S marked).



- Wide tread, 5 robust ribs, for superb mileage and even wear and low noise (fulfilling future EU regulations)
- Centerline blocks with edge and flexomatic blading for good braking on wet and all season capability.
- Reinforced sidewalls, with wear indicators, to resist to curb scuffing and enhanced durability and damage resistance
- Regroovable and retreadable

## Technical Data



Size	Load Index	Speed Symbol	Size	Load Index	Speed Symbol
295/80R22.5	152/148 (154/150)	J (E)	265/70R19.5	140/138	L
275/70R22.5	148/145 (152/148)	J (E)	245/70R19.5	136/134	L
315/60R22.5	152/148	J			





# UrbanMax MCD Traction



The new MCD Traction municipal drive tyre, featuring UrbanMax Technology, a combination of latest technology tread pattern and state of the art materials.

UrbanMax MCD Traction tyres are specifically developed to provide excellent traction, both in normal and winter applications ( M+S marked). In addition it provides superb mileage, good braking. MCD Traction tyres are specifically designed for drive axle use on municipal vehicles.



- 6 row block type patten fro excellent traction performance, even in winter conditions.
- The wide tread with deep profile depth ensures excellent mileage performance, even wear and low noise (complying with future EU noise regulation)
- Reinforced sidewalls, with wear indicators, to resist to curb scuffing and enhaced durability and damage resistance
- Regroovable and retreadable

## Technical Data



Size	Load Index	Speed Symbol
275/70R22.5	152/148 (154/150)	J (E)

# UrbanMax MCD Super Single



Specifically designed super single tyre for urban bus applications. The 455/45R22.5 is an alternative to dual mounted 275/70R22.5 tyres, providing more inside space, reduced weight and lower rolling resistance.



- Reduced weight
- Lower Rolling Resistance
- Increased inside space

## Technical Data



Size	Load Index	Speed Symbol
455/45R22.5	166	J

# UltraGrip WTS



Goodyear's UltraGrip, the benchmark in winter tyres, has now been developed for commercial vehicles resulting in the new Goodyear Ultra Grip WTS tyre. Setting new standards of performance in extreme winter conditions, it gives you all the grip you need in places such as the Scandinavian region or the Alps.



- Excellent braking (and traction) on wet and snow
- Superb lateral grip, handling and steering stability
- High mileage, even wear pattern
- Usable as "all position" fitment on coaches

## Technical Data



Size	Load Index	Speed Symbol	Size	Load Index	Speed Symbol
315/80R22.5	156/150 (154/150)	K (M)	315/60R22.5	152/148	L
295/80R22.5	152/148	L	295/60R22.5	150/147 (149/146)	K (L)
315/70R22.5	154/150 (152/148)	K (M)	385/55R22.5	160 (158)	K (L)
275/70R22.5	148/145 (152/148)	J (E)	355/50R22.5	154 (152)	K (L)
385/65R22.5	160 (158)	K (L)	12R22.5	152/148	K

# UltraGrip WTD



The new Ultra Grip WTD perfectly complements Goodyear's Ultra Grip WTS steer axle tyre line. With the new 3D-BIS Technology unique to Goodyear, traction as well as stability and braking are improved due to the tread "Block Interlocking System".



- Excellent winter traction and braking (snow and ice)
- Superb lateral grip, handling and steering stability
- High mileage, even wear pattern
- Robust, durable carcass, improved durability and retreadability
- Minimized "stone holding"

## Technical Data



Size	Load Index	Speed Symbol	Size	Load Index	Speed Symbol
315/80R22.5	156/150 (154/150)	K (M)	315/60R22.5	152/148	L
295/80R22.5	152/148	L	295/60R22.5	150/147 (149/146)	K (L)
315/70R22.5	154/150 (152/148)	K (M)	12R22.5	152/148	K



# Technical Data





# Trucks, Tractors and Buses

Size	Design	LI&SS (2nd LI&SS)	OD (mm)	Max. OD (mm)	SD (mm)	Max. SD (mm)	SLR (mm)	RCCF (mm)	Min. DSP	Tube	Flap	Rec. Rim	Opt. Rim
<b>17.5" sizes - 70 series</b>													
245/70R17.5	RHS II, RHD II	136/134 M	789	803	248	258	364	2400	270	-	-	6,75	7,50
265/70R17.5	RHS II, RHD II	139/136 M	817	831	262	272	376	2490	295	-	-	7,50	6,75/8,25
<b>17.5" sizes - 75 series</b>													
205/75R17.5	RHS II	124/122 M	753	765	196	212	353	2297	231	-	-	6,00	5,25/6,75
	RHD II	124/122 M (16/124 G)											
215/75R17.5	RHS II, RHD II	126/124 M	767	779	211	219	359	2339	239	-	-	6,00	6,75
225/75R17.5	RHS II, RHD II	129/127 M	783	797	218	235	366	2388	246	-	-	6,75	6,00
235/75R17.5	RHS II, RHD II	132/130 M	797	811	233	242	372	2431	262	-	-	6,75	7,50
<b>17.5" sizes - standard series</b>													
7R17.5C	G291	108/107 M	752		185		353	2294	208	-	-	5,25	
8R17.5	G291	117/116 M	784	797	208	216	367	2391	225	-	-	5,25	6,00/6,75
8.5R17.5	RHS, RHD	121/120 M	802	817	215	224	374	2446	233	-	-	5,25	6,00/6,75
9.5R17.5	RHS II, RHD II	129/127 M	842	857	240	250	391	2568	261	-	-	6,00	6,75
10R17.5	G124, G291	134/132 M	858	875	254	264	398	2617	277	-	-	6,75	7,50
<b>19.5" sizes - 55 series</b>													
265/55R19.5	LHD II	136/134 M	787	799	264	275	368	2400	297	-	-	8,25	
<b>19.5" sizes - 70 series</b>													
245/70R19.5	RHS II, RHD II	136/134 M	839	853	248	258	389	2559	270	-	-	6,75	7,50
	MCA	136/134 L											
265/70R19.5	RHS II, RHD II	140/138 M	867	881	262	272	401	2644	295	-	-	7,50	6,75/8,25
	MCA	140/138 L											
285/70R19.5	RHS II, RHD II	146/144 L (144/142 M)	895	911	283	294	413	2730	311	-	-	7,50	8,25/9,00
305/70R19.5	RHS II, RHD II	148/145 M	923	941	305	317	424	2815	334	-	-	8,25	9,00
<b>22.5" sizes - 45 series</b>													
495/45R22.5	LHD	169 K	1018	1036	499	519	473	3085		-	-	17,00	
455/45R22.5	MCD	166 J	982	998	466	471	458	3000		-	-	15,00	
<b>22.5" sizes - 50 series</b>													
375/50R22.5	LHS II	156 K	948	964	374	389	444	2870		-	-	11,75	11,75/12,25
355/50R22.5	LHS II, WTS	154 K (152 L)	928	942	361	375	435	2810				11,75	10,50
<b>22.5" sizes - 55 series</b>													
385/55R22.5	LHS II, WTS	160 K (158 L)	996	1012	386	401	456	3040		-	-	11,75	12,25
295/55R22.5	LHD II	147/145 K	896	908	292	304	420	2733	329	-	-	9,00	9,75

Rec. Inft. (bar)	Single Dual	LI	5.0	5.5	6.0	6.25	6.5	6.75	7.0	7.25	7.5	7.75	8.0	8.25	8.5	8.75	9.0
8.50	s	136	2940	3170	3400	3510	3620	3730	3840	3950	4060	4170	4270	4380	4480		
8.50	d	134	5550	5990	6420	6640	6850	7060	7270	7470	7680	7880	8080	8280	8480		
8.00	s	139	3340	3610	3870	3990	4120	4250	4370	4500	4620	4740	4860				
8.00	d	136	6160	6640	7120	7360	7590	7830	8060	8290	8510	8740	8960				
7.50	s	124	2320	2500	2680	2770	2860	2950	3030	3120	3200						
7.50	d	122	4340	4690	5020	5190	5360	5520	5680	5840	6000						
	s	126	2460	2660	2850	2940	3040	3130	3220	3310	3400						
	d	124	4630	5000	5360	5540	5710	5890	6060	6230	6400						
7.00	s	126	2600	2810	3010	3110	3210	3310	3400								
7.00	d	124	4890	5280	5660	5850	6040	6220	6400								
7.25	s	129	2750	2970	3190	3290	3400	3500	3600	3700							
7.25	d	127	5210	5620	6020	6220	6420	6620	6810	7000							
7.75	s	132	2820	3050	3260	3370	3480	3590	3690	3800	3900	4000					
7.75	d	130	5360	5780	6200	6400	6610	6810	7010	7210	7410	7600					
5.00	s	108	2000														
5.00	d	107	3900														
6.00	s	117	2230	2400	2570												
6.00	d	116	4330	4670	5000												
6.25	s	121	2430	2620	2810	2900											
6.25	d	120	4690	5060	5430	5600											
7.50	s	129	2680	2890	3100	3200	3300	3410	3510	3610	3700						
7.5	d	127	5070	5470	5860	6050	6250	6440	6630	6820	7000						
8.00	s	134	2920	3150	3370	3490	3600	3710	3820	3920	4030	4140	4240				
8.00	d	132	5500	5930	6360	6570	6780	6990	7190	7400	7600	7800	8000				
9.00	s	136	2800	3030	3240	3350	3460	3560	3670	3770	3880	3980	4080	4180	4280	4390	4480
	d	134	5300	5720	6140	6340	6540	6740	6940	7140	7330	7530	7720	7910	8110	8300	8480
8.25	s	136	3010	3240	3480	3590	3710	3820	3930	4050	4160	4270	4380	4480			
8.25	d	134	5690	6140	6580	6800	7010	7230	7440	7650	7860	8070	8280	8480			
7.75	s	140	3530	3810	4080	4210	4350	4480	4610	4750	4880	5000					
7.75	d	138	6650	7180	7700	7950	8210	8460	8710	8950	9200	9440					
9.00	s	146	3750	4050	4340	4490	4630	4770	4910	5050	5190	5330	5470	5600	5740	5870	6000
9.00	d	144	7000	7560	8100	8370	8640	8900	9170	9430	9680	9940	10200	10450	10700	10960	11200
8.25	s	144	3760	4050	4350	4490	4630	4770	4920	5060	5190	5330	5470	5600			
8.25	d	142	7110	7670	8220	8490	8760	9030	9300	9560	9830	10090	10350	10600			
8.50	s	148	4130	4450	4770	4930	5090	5240	5400	5550	5700	5860	6010	6160	6300		
8.50	d	145	7590	8190	8780	9080	9360	9650	9940	10220	10500	10780	11060	11330	11600		
9.00	s	169	7250	7830	8390	8670	8950	9220	9490	9760	10030	10300	10560	10820	11090	11350	11600
9.00	d	166	6630	7150	7670	7920	8180	8430	8670	8920	9170	9410	9650	9890	10130	10370	10600
9.00	s	156	5000	5400	5790	5980	6170	6360	6550	6730	6920	7100	7290	7470	7650	7830	8000
9.00	s	154	4690	5060	5430	5610	5780	5960	6140	6310	6490	6660	6830	7000	7170	7340	7500
8.50	s	152	4650	5020	5380	5560	5730	5910	6080	6260	6430	6600	6770	6940	7100		
9.00	s	160	5630	6070	6510	6730	6940	7150	7370	7580	7780	7990	8200	8400	8600	8800	9000
8.50	s	158	5560	6010	6440	6650	6860	7070	7280	7490	7700	7900	8100	8300	8500		
9.00	s	147	3850	4150	4450	4600	4750	4890	5030	5180	5320	5460	5600	5740	5880	6030	6150
9.00	d	145	7250	7830	8390	8670	8950	9220	9490	9760	10030	10300	10560	10820	11090	11350	11600

# Trucks, Tractors and Buses

Size	Design	L1&SS (2nd L1&SS)	OD (mm)	Max. OD (mm)	SD (mm)	Max. SD (mm)	SLR (mm)	RCCF (mm)	Min. DSP	Tube	Flap	Rec. Rim	Opt. Rim
<b>22.5" sizes - 60 series</b>													
295/60R22.5	LHS II, LHD II, RHS II, RHD II, WTD, WTS	150/147 K (149/146 L)	926	940	292	304	435	2806	329	-	-	9,00	9,75
<b>22.5" sizes - 65 series</b>													
315/60R22.5	LHS II, LHD II, RHS II, RHD II, WTD MCA	152/148 L 152/148 J	950	966	313	326	445	2879	344	-	-	9,00	9,75
<b>22.5" sizes - 70 series</b>													
385/65R22.5	LHS II, RHS II, WTS, MSS	160 K (158 L)	1072	1092	389	405	496	3248	-	-	11,75	12,25	
<b>22.5" sizes - 75 series</b>													
255/70R22.5	G169RSA G164RTD	140/137 M 140/137 M (140/140 L)	930	945	247	265	429	2837	278	-	-	6,75	7.50/8.25
275/70R22.5	LHS II, LHD II, RHD II, RHS II MCA, MCD Traction, WTS City MSS	148/145 M 148/145 J (152/148 E) 148/145 K	958	974	276	287	445	2922	303	-	-	7,50	8,25
305/70R22.5	LHS II, LHD II, RHS II, RHD II	152/148 L (150/148 M)	1000		305		463	3050	334	-	-	8,25	9,00
315/70R22.5	LHS II, LHD II, RHS II, RHD II WTS, WTD	154/150 L (152/148 M) 154/150 K (152/148 L)	1014	1018	312	317	468,2813	3093	351	-	-	9,00	9,75
<b>22.5" sizes - 75 series</b>													
445/75R22.5	MSS	170 J	1240	1266	444	462	569,8625	3782	-	-	14,00		
<b>22.5" sizes - 80 series</b>													
275/80R22.5	G391	149/146 L (148/145 M)	1012	1030	276	287	472,9625	3087	303	-	-	7,50	8,25
295/80R22.5	LHS II, LHD II, RHS II, RHD II, LHS LR8 MSD, MSS MCA WTS, WTD	152/148 M 152/148 K 152/148 J (154/150 E) 152/148 L	1044	1062	298	310	486,5625	3184	326	-	-	8,25	9,00
315/80R22.5	WTS LHS II, LHD II, RHS II, RHD II, WTD, LHS LR8 MSS, MSD	156/150 K (154/150 L) 156/150 L (154/150 M) 156/150 K	1076	1096	312	319	500,1625	3282	351	-	-	9,00	9,75
<b>22.5" sizes - 90 series</b>													
375/90R22.5	MSS, ORD, MSD	164/160 G	1248	1276	369	387	573,2625	3806	-	-	11,75	10,50	



Rec. Inft. (bar)	Single Dual	LI	5.0	5.5	6.0	6.25	6.5	6.75	7.0	7.25	7.5	7.75	8.0	8.25	8.5	8.75	9.0
9.00	s	150	4190	4520	4850	5010	5170	5330	5480	5640	5800	5950	6100	6250	6410	6560	6700
9.00	d	147	7690	8300	8900	9190	9490	9780	10060	10350	10640	10920	11200	11480	11760	12030	12300
9.00	s	149	4070	4390	4700	4860	5020	5170	5320	5470	5620	5770	5920	6070	6210	6360	6500
9.00	d	146	7500	8100	8680	8970	9250	9540	9820	10100	10380	10650	10930	11200	11470	11740	12000
9.00	s	152	4440	4790	5140	5310	5480	5650	5810	5980	6140	6300	6470	6630	6790	6950	7100
9.00	d	148	7880	8500	9110	9420	9720	10010	10310	10600	10890	11180	11470	11760	12040	12320	12600
9.00	s	160	5630	6070	6510	6730	6940	7150	7370	7580	7780	7990	8200	8400	8600	8800	9000
8.50	s	158	5560	6010	6440	6650	6860	7070	7280	7490	7700	7900	8100	8300	8500		
8.25	s	140	3350	3620	3880	4010	4140	4260	4390	4510	4640	4760	4880	5000			
8.25	d	137	6170	6660	7140	7370	7610	7840	8070	8300	8530	8760	8980	9200			
8.25	s	140	3350	3620	3880	4010	4140	4260	4390	4510	4640	4760	4880	5000			
8.25	d	140	6700	7230	7760	8010	8270	8520	8770	9020	9270	9520	9760	10000			
9.00	s	148	3940	4250	4560	4710	4860	5010	5160	5300	5450	5590	5740	5880	6020	6160	6300
9.00	d	145	7250	7830	8390	8670	8950	9220	9490	9760	10030	10300	10560	10820	11090	11350	11600
9.00	s	152	4440	4790	5140	5310	5480	5650	5810	5980	6140	6300	6470	6630	6790	6950	7100
9.00	d	148	7880	8500	9110	9420	9720	10010	10310	10600	10890	11180	11470	11760	12040	12320	12600
9.00	s	152	4440	4790	5140	5310	5480	5650	5810	5980	6140	6300	6470	6630	6790	6950	7100
9.00	d	148	7880	8500	9110	9420	9720	10010	10310	10600	10890	11180	11470	11760	12040	12320	12600
9.00	s	150	4390	4730	5080	5240	5410	5580	5740	5900	6070	6230	6390	6550	6700	6860	7020
9.00	d	148	7880	8500	9110	9420	9720	10010	10310	10600	10890	11180	11470	11760	12040	12320	12600
9.00	s	154	4690	5060	5430	5610	5790	5960	6140	6310	6490	6660	6830	7000	7170	7340	7500
9.00	d	150	8380	9040	9690	10010	10330	10650	10960	11280	11590	11890	12200	12500	12810	13110	13400
8.50	s	152	4650	5020	5380	5560	5730	5910	6080	6260	6430	6600	6770	6940	7100		
8.50	d	148	8250	8900	9540	9860	10170	10480	10790	11100	11400	11710	12010	12310	12600		
8.00	s	170	8240	8900	9540	9850	10170	10480	10790	11100	11400	11700	12000				
8.50	s	149	4260	4590	4920	5090	5250	5410	5570	5730	5890	6040	6200	6350	6500		
8.50	d	146	7850	8480	9090	9390	9690	9980	10280	10570	10860	11150	11440	11720	12000		
8.50	s	148	4130	4450	4770	4930	5090	5240	5400	5550	5700	5860	6010	6160	6300		
8.50	d	145	7590	8190	8780	9080	9360	9650	9940	10220	10500	10780	11060	11330	11600		
8.50	s	152	4650	5020	5380	5560	5730	5910	6080	6260	6430	6600	6770	6940	7100		
8.50	d	148	8250	8900	9540	9860	10170	10480	10790	11100	11400	11710	12010	12310	12600		
8.50	s	154	4910	5300	5680	5870	6060	6240	6430	6610	6790	6970	7150	7330	7500		
8.50	d	150	8770	9460	10150	10480	10820	11150	11480	11800	12130	12450	12770	13090	13400		
8.50	s	156	5240	5650	6060	6260	6460	6660	6850	7050	7240	7440	7630	7820	8000		
8.00	d	150	9210	9930	10650	11000	11350	11700	12050	12390	12730	13070	13400				
8.00	s	154	5150	5560	5960	6160	6360	6550	6750	6940	7130	7320	7500				
8.00	d	150	9210	9930	10650	11000	11350	11700	12050	12390	12730	13070	13400				
7.50	s	164	7230	7810	8370	8650	8920	9200	9470	9740	10000						
	d	160	13020	14050	15060	15560	16060	16550	17040	17520	18000						

# Trucks, Tractors and Buses

Size	Design	LI&SS (2nd LI&SS)	OD (mm)	Max. OD (mm)	SD (mm)	Max. SD (mm)	SLR (mm)	RCCF (mm)	Min. DSP	Tube	Flap	Rec. Rim	Opt. Rim
<b>22.5" sizes - standard series</b>													
10R22.5	G391	144/142 M	1020	1038	254	264	476,3625	3111	277	-	-	6,75	7,50
11R22.5	MSS	148/145 K	1050	1070	279	290	489,1125	3203	305	-	-	7,50	8,25
	MCS*	148/145 J (152/148 E)											
	RHS II, RHD II, G293	148/145 L											
	LHS LR8	148/145 M											
12R22.5	MSD, MSS, WTD, MSD hct	152/148 K	1084	1104	300	312	503,5625	3306	329	-	-	8,25	9,00
	WTS	152/148 K (150/146 L)											
	RHS II, RHD II, G293, RHD hct, LHS LR8	152/148 L											
	MCS*	152/148 J (154/150 E)											
	ORD	152/148 J											
13R22.5	RHS II, RHD II	156/150 L	1124	1146	312	326	520,5625	3428	351	-	-	9,00	9,75
	MSS, MSD	156/150 K											
	ORD	156/150 G											
<b>24.5" sizes</b>													
305/75R24.5	G358 LHS	154/149 L	1080	1098	305	317	505,6725	3294	334	-	-	9,00	8,25
12R24.5	G286	152/149 L	1135		300		525,2375	3462		-	-	9,00	8,25
<b>20" &amp; 24" sizes - standard series</b>													
10.00R20	G293	147/143 K	1052	1074	275	286	485,2	3209	316	10.00R20	20R8.0	7,50	6.50/86.50 7.00/87.00 7.33V/7.50 8.5V/8.0 8.0V/88.0
11.00R20	G293, G386, G286	150/146 K	1082	1104	286	297	497,95	3300	329	11.00R20	20R8.0	8,00	7.33V/7.5 8.5V/8.0V 8.0V/8.5 8.5V/88.5 9.0
12.00R20	MSD, MSS LR8, G386, G293	154/150 K	1118	1146	297	319	513,25	3410	360	12.00R20	20R8.5	8,50	7.33V/7.5 8.5V/8.0 8.0V/88.0 8.5 8.5V/88.5 9.0/9.0V
	ORD	154/150 G											
14.00R20	ORD	164/160 G	1238	1268	370	377	564	3780	426			10,00	9.0/10.00V 10.00W
12.00R24	G293	156/153 K	1226	1250	313	319	566,77	3739	360	12.00R24	24R8.5	8,50	8.50V/88.5 9.0/9.00V
	MSD, MSS, G293A, G386A	160/156 K								12.00R24	24R8.5		
	ORD	160/156 G								12.00R24	24R8.5		
<b>20" sizes - 85 series</b>													
365/85R20	ORD	164 J	1128	1152	364	379	518	3440				10,00	

Rec. Inft. (bar)	Single Dual	LI	5.0	5.5	6.0	6.25	6.5	6.75	7.0	7.25	7.5	7.75	8.0	8.25	8.5	8.75	9.0
8.50	s	144	3670	3960	4240	4380	4520	4660	4800	4940	5070	5120	5340	5470	5600		
8.50	d	142	6940	7490	8030	8290	8560	8820	9080	9340	9600	9850	10100	10350	10600		
8.50	s	148	4130	4450	4770	4930	5090	5240	5400	5550	5700	5860	6010	6160	6300		
8.50	d	145	7590	8190	8780	9080	9360	9650	9940	10220	10500	10780	11060	11330	11600		
8.50	s	152	4650	5020	5380	5560	5730	5910	6080	6260	6430	6600	6770	6940	7100		
8.50	d	148	8250	8900	9540	9860	10170	10480	10790	11100	11400	11710	12010	12310	12600		
8.50	s	152	4650	5020	5380	5560	5730	5910	6080	6260	6430	6600	6770	6940	7100		
8.50	d	148	8250	8900	9540	9860	10170	10480	10790	11100	11400	11710	12010	12310	12600		
8.00	s	150	4610	4970	5330	5500	5680	5850	6030	6200	6370	6540	6700				
8.00	d	146	8240	8900	9540	9850	10170	10480	10790	11100	11400	11700	12000				
8.50	s	154	4910	5300	5680	5870	6060	6240	6430	6610	6790	6970	7150	7330	7500		
8.50	d	150	8770	9460	10150	10480	10820	11150	11480	11800	12130	12450	12770	13090	13400		
8.75	s	156	5120	5520	5920	6120	6310	6510	6700	6890	7080	7260	7450	7640	7820	8000	
8.75	d	150	8570	9250	9910	10240	10570	10890	11210	11530	11850	12170	12480	12790	13100	13400	
8.50	s	154	4910	5300	5680	5870	6060	6240	6430	6610	6790	6970	7150	7330	7500		
8.50	d	150	8770	9460	10150	10480	10820	11150	11480	11800	12130	12450	12770	13090	13400		
8.50	s	154	4910	5300	5680	5870	6060	6240	6430	6610	6790	6970	7150	7330	7500		
8.50	d	149	8510	9180	9840	10170	10490	10820	11130	11450	11770	12080	12390	12700	13000		
8.25	s	152	4760	5140	5510	5690	5870	6050	6230	6410	6580	6760	6930	7100			
8.25	d	149	8710	9400	10080	10420	10750	11080	11400	11730	12050	12370	12690	13000			
8.00	s	147	4230	4560	4890	5050	5210	5370	5530	5690	5850	6000	6150				
8.00	d	143	7490	8080	8660	8950	9240	9520	9800	10080	10360	10630	10900				
8.25	s	150	4490	4850	5200	5370	5540	5710	5880	6050	6210	6380	6540	6700			
8.50	s	154	4910	5300	5680	5870	6060	6240	6430	6610	6790	6970	7150	7330	7500		
8.50	d	150	8770	9460	10150	10480	10820	11150	11480	11800	12130	12450	12770	13090	13400		
7.50	s	164	7230	7810	8370	8650	8920	9200	9470	9740	10000						
7.50	d	160	13020	14050	15060	15560	16060	16550	17040	17520	18000						
7.75	s	156	5640	6090	6520	6740	6950	7170	7380	7590	7800	8000					
7.75	d	153	10290	11100	11900	12300	12690	13080	13460	13850	14230	14600					
8.50	s	160	5890	6360	6820	7040	7270	7490	7710	7930	8150	8360	8580	8790	9000		
8.50	d	156	10470	11300	12110	12510	12910	13310	13700	14090	14480	14870	15250	15630	16000		
8.00	s	164	6870	7410	7950	8210	8470	8730	8990	9250	9500	9750	10000				

# Trailers

Size	Design	L&SS (2nd L&SS)	OD (mm)	Max. OD (mm)	SD (mm)	Max. SD (mm)	SLR (mm)	RCCF (mm)	Min. DSP	Tube	Flap	Rec. Rim	Opt. Rim
<b>15" sizes - standard series</b>													
7.50R15	RHT	135/133 K	772	792	212	229	357	2355	244	7.50R15FB	15R6.0	6,00	6.50/86.50
8.25R15	RHT	143/141 J	836	859	234	253	384	2550	269	8.25R15FB	15R6.0	6,50	6.00/7.00
<b>17.5" sizes - 65 series</b>													
205/65R17.5	LHT	127/125 J (129/129 F)	711	721	204	212	329	2154	231	-	-	6,00	6,75
<b>17.5" sizes - 70 series</b>													
245/70R17.5	LHT	143/141 J (146/144 F)	789	803	248	258	360	2406	270	-	-	6,75	7,50
<b>17.5" sizes - 75 series</b>													
215/75R17.5	LHT	135/133 J	767	779	211	219	351	2324	239	-	-	6,00	6,75
235/75R17.5	LHT	143/141 J (144/144 F)	797	811	233	242	363	2431	262	-	-	6,75	7,50
<b>17.5" sizes - standard series</b>													
9.5R17.5	LHT	143/141 J	842	857	240	250	381	2568	261	-	-	6,00	6,75
10R17.5	G114	134/132	912	875	254	264	409	2782	277	-	-	6,75	7,50
<b>19.5" sizes - 50 series</b>													
435/50R19.5	LHT+	160 J	931	949	438	456	422	2840	-	-	14,00	15,00	
<b>19.5" sizes - 55 series</b>													
265/55R19.5	LHT	141/140 J (142/142 G)	787	799	264	275	368	2400	297	-	-	8,25	
<b>19.5" sizes - 70 series</b>													
245/70R19.5	LHT	141/140 J	839	853	248	258	385	2559	270	-	-	6,75	7,50
265/70R19.5	LHT	143/141 J	867	881	262	272	396	2644	295	-	-	7,50	8,25
	MSS	143/141 J (140/138 L)											
285/70R19.5	LHT	150/148 J	895	911	283	294	408	2730	318	-	-	8,25	9,00
<b>22.5" sizes - 40 series</b>													
455/40R22.5	LHT+	160 J	936	950	453	471	439	2850				15,00	16,00
<b>22.5" sizes - 50 series</b>													
435/50R22.5	LHT	164 J	1008	1026	438	456	460	3074	-	-	14,00	15,00	
375/50R22.5	LHS II	156 K	948	964	374	389	444	2870	-	-	11,75	11.75/12.25	
<b>22.5" sizes - 55 series</b>													
385/55R22.5	LHT+, RHT	160 K (158 L)	996	1012	386	401	456	3040	-	-	11,75	12,25	
<b>22.5" sizes - 65 series</b>													
385/65R22.5	LHT, RHT, G465A	160 K (158 L)	1072	1092	389	405	496	3248	-	-	11,75	12,25	
	MST	160 J (158 K)											
425/65R22.5	RHT, G286A	165 K	1124	1146	430	447	518	3406	-	-	13,00	14,00	
445/65R22.5	RHT, MST	169 K	1150	1174	454	472	529	3485	-	-	14,00		
<b>22.5" sizes - standard series</b>													
11R22.5	LHT	148/145 J (146/143 L)	1050	1070	279	290	489	3203	305	-	-	7,50	8,25

Rec. Inft. (bar)	Single Dual	LI	5.0	5.5	6.0	6.25	6.5	6.75	7.0	7.25	7.5	7.75	8.0	8.25	8.5	8.75	9.0
8.50	s	135	2860	3080	3300	3410	3520	3630	3740	3840	3950	3950	4160	4260	4360		
8.50	d	133	5390	5820	6240	6450	6650	6860	7060	7260	7460	7660	7850	8050	8240		
8.50	s	143	3570	3850	4130	4270	4400	4540	4670	4800	4940	5070	5200	5330	5450		
8.50	d	141	6740	7280	7800	8060	8320	8570	8820	9070	9320	9570	9820	10060	10300		
8.50	s	127	2290	2480	2650	2740	2830	2920	3000	3090	3170	3260	3340	3420	3500		
8.50	d	125	4320	4660	5000	5170	5330	5490	5660	5820	5980	6130	6290	6450	6600		
8.50	s	129	2430	2620	2810	2900	2990	3080	3170	3260	3350	3440	3530	3620	3700		
8.50	d	129	4850	5230	5610	5790	5980	6160	6340	6520	6700	6880	7050	7230	7400		
8.75	s	143	3490	3760	4040	4170	4300	4430	4560	4690	4820	4950	5080	5200	5330	5450	
8.75	d	141	6590	7110	7620	7870	8130	8370	8620	8870	9110	9350	9590	9830	10070	10300	
8.75	s	146	3580	3870	4150	4280	4420	4560	4690	4820	4960	5090	5220	5350	5480	5600	
8.75	d	144	7160	7730	8290	8560	8830	9110	9370	9640	9910	10170	10430	10690	10950	11200	
8.50	s	135	2860	3080	3300	3410	3520	3630	3740	3840	3950	4050	4160	4260	4360		
8.50	d	133	5390	5820	6240	6450	6650	6860	7060	7260	7460	7660	7850	8050	8240		
8.75	s	143	3490	3760	4040	4170	4300	4430	4560	4690	4820	4950	5080	5200	5330	5450	
8.75	d	141	6590	7110	7620	7870	8130	8370	8620	8870	9110	9350	9590	9830	10070	10300	
8.75	s	144	3580	3870	4150	4280	4420	4560	4690	4820	4960	5090	5220	5350	5480	5600	
8.75	d	144	7160	7730	8290	8560	8830	9110	9370	9640	9910	10170	10430	10690	10950	11200	
8.75	s	143	3490	3760	4040	4170	4300	4430	4560	4690	4820	4950	5080	5200	5330	5450	
8.75	d	141	6590	7110	7620	7870	8130	8370	8620	8870	9110	9350	9590	9830	10070	10300	
8.00	s	134	2920	3150	3370	3490	3600	3710	3820	3920	4030	4140	4240				
8.00	d	132	5500	5930	6360	6570	6780	6990	7190	7400	7600	7800	8000				
9.00	s	165	5630	6070	6510	6730	6940	7150	7370	7580	7780	7990	8200	8400	8600	8800	9000
9.00	s	141	3220	3480	3730	3850	3970	4100	4220	4340	4460	4570	4690	4810	4920	5040	5150
9.00	d	140	6250	6750	7230	7470	7710	7950	8180	8420	8650	8880	9110	9330	9560	9780	10000
9.00	s	142	3320	3580	3840	3960	4090	4220	4340	4460	4590	4710	4830	4950	5070	5190	5300
9.00	d	142	6630	7150	7670	7920	8180	8430	8670	8920	9170	9410	9650	9890	10130	10370	10600
8.50	s	141	3370	3640	3900	4030	4160	4290	4410	4540	4660	4790	4910	5030	5150		
8.50	d	140	6550	7060	7570	7820	8070	8320	8570	8810	9050	9290	9530	9770	10000		
8.50	s	143	3570	3850	4130	4270	4400	4540	4670	4800	4940	5070	5200	5330	5450		
8.50	d	141	6740	7280	7800	8060	8320	8570	8820	9070	9320	9570	9820	10060	10300		
8.50	s	140	3720	4010	4300	4450	4590	4730	4870	5000	5140	5280	5410	5550	5680		
8.50	d	138	7020	7570	8120	8390	8660	8920	9180	9440	9700	9960	10220	10470	10730		
9.00	s	150	4190	4520	4850	5010	5170	5330	5480	5640	5800	5950	6100	6250	6410	6560	6700
9.00	d	148	7880	8500	9110	9420	9720	10010	10310	10600	10890	11180	11470	11760	12040	12320	12600
9.00	s	160	5630	6070	6510	6730	6940	7150	7370	7580	7780	7990	8200	8400	8600	8800	9000
9.00	s	164	6250	6750	7230	7470	7710	7950	8180	8420	8650	8880	9110	9330	9560	9780	10000
9.00	s	156	5000	5400	5790	5980	6170	6360	6550	6730	6920	7100	7290	7470	7650	7830	8000
9.00	s	160	5630	6070	6510	6730	6940	7150	7370	7580	7780	7990	8200	8400	8600	8800	9000
8.50	s	158	5560	6010	6440	6650	6860	7070	7280	7490	7700	7900	8100	8300	8500		
9.00	s	160	5630	6070	6510	6730	6940	7150	7370	7580	7780	7990	8200	8400	8600	8800	9000
8.50	s	158	5560	6010	6440	6650	6860	7070	7280	7490	7700	7900	8100	8300	8500		
8.25	s	165	6910	7450	7990	8250	8520	8780	9040	9290	9550	9800	10050	10300			
9.00	s	169	7250	7830	8390	8670	8950	9220	9490	9760	10030	10300	10560	10820	11090	11350	11600
8.50	s	148	4130	4450	4770	4930	5090	5240	5400	5550	5700	5860	6010	6160	6300		
8.50	d	145	7590	8190	8780	9080	9360	9650	9940	10220	10500	10780	11060	11330	11600		
8.50	s	146	3930	4240	4550	4700	4850	4990	5140	5290	5430	5580	5720	5860	6000		
8.50	d	143	7130	7700	8250	8530	8800	9070	9340	9600	9870	10130	10390	10650	10900		

# Regrooving Guidelines

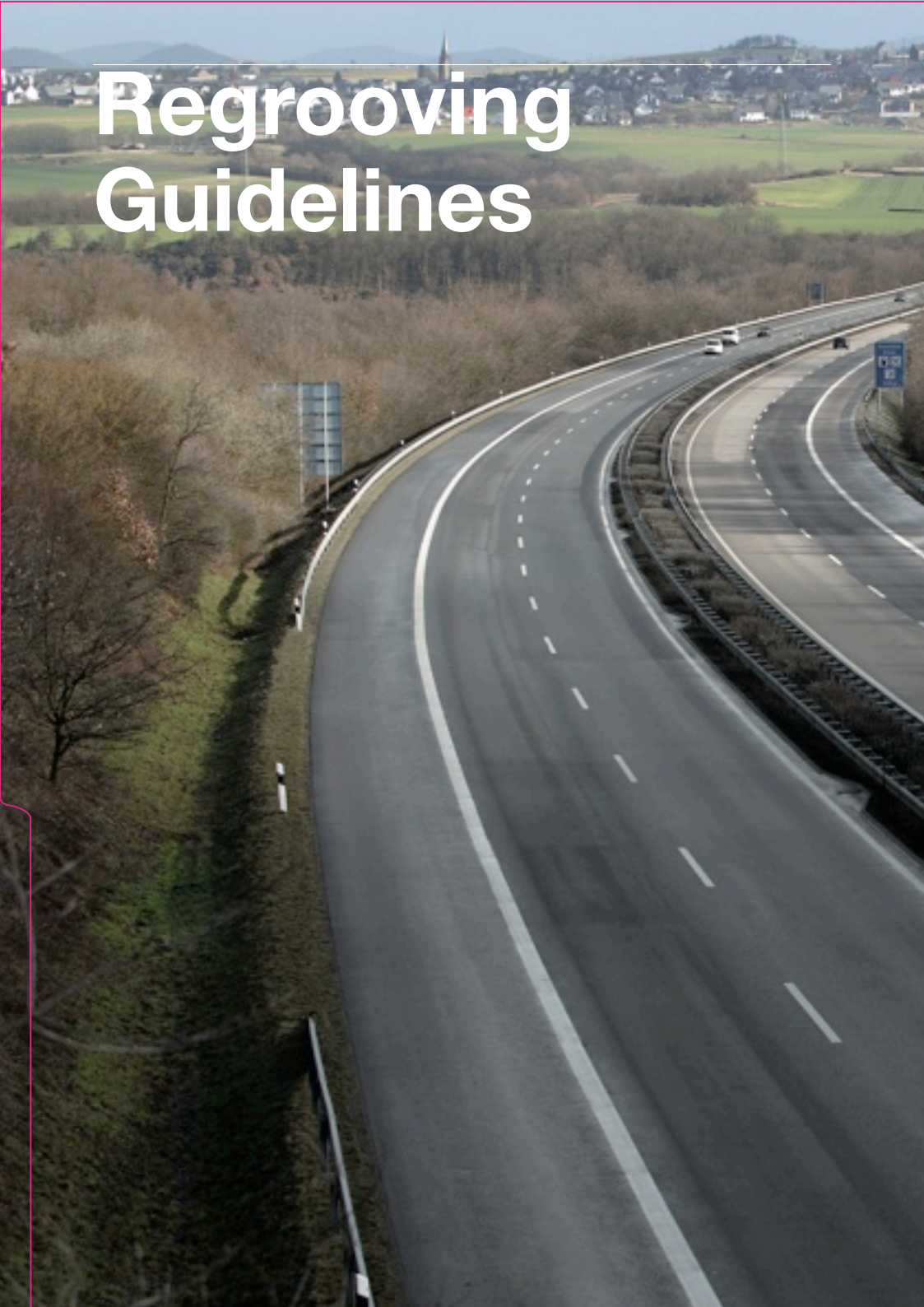



---

# Regrooving Guidelines

---

Depending on conditions of use and maintenance, Goodyear's high-quality tyre casings can give each tyre a minimum of four lives (new, regrooved, retread, regrooved retread) while ensuring safety, performance and minimising operating costs.

---

## Regrooving basics

---

1. A regrooved tyre is a tyre, either new or retreaded tyre, on which the tread pattern has been renewed or a new tread pattern has been produced by cutting into the tread deeper than the original moulded groove depth.
2. The regrooving of truck tyres should be entrusted solely to fully trained operators.
3. Only proven regrooving tools with electrically heated blades should be used.
4. A minimum of remaining undertread rubber is essential to avoid damage at the top breaker belt, groove cracking and/or stone damage.
5. If regrooved according to the recommendations outlined in this manual, Goodyear tyres can, in principle, be mounted on all wheel positions. However, since it has become standard practice for users to normally fit new tyres on front axles, the regrooved tyres will usually be mounted on the rear axles or trailer positions.
6. Tyres which are heavily damaged in the tread area (e.g. rib tearing, multiple cutting and chipping) should not be regrooved but retreaded.

All tyres that are marked 'Regroovable' in the sidewall areas have extra undertread thickness for regrooving purposes.

---

## Regrooving recommendations

---

1. Under NO circumstances should the tyre be completely worn before regrooving. It is strongly recommended to regroove when 3 to 6 mm of the original design is still left.
2. Determine the blade setting depth for each individual tyre as follows:
  - a) Measure the remaining groove depth AT THE POINT OF LOWEST TREAD DEPTH;
  - b) Set the blade in the cutter head to the 'minimum remaining groove depth' + 3 mm maximum regrooving depth.  
This will maintain a 3 mm gauge under the regrooved tread.
3. While regrooving, hold the cutter so that the underside of the cutting head is flush against the tread surface.
4. The maximum regrooving depth for all Goodyear tyres is 3 mm.
5. If the wear is irregular, probing of the remaining undertread gauge is necessary to ensure that 3 mm of undertread will remain after regrooving.



---

## Regrooving Goodyear remould tyres

---

Provided that the retreading process is on Goodyear casings carried out by Goodyear Authorised Retreader, Goodyear remould tyres may be regrooved to the same pattern as the new tyre, with a maximum regrooving depth of 3 mm.

---

## Regrooving parameters

---

Regroove Goodyear truck tyres when there is still sufficient tread depth. Suggested remaining tread depths are: 3-4 mm for regular highway use; 5-6 mm in operating conditions where penetration damage is likely.

---

Regrooving depth indicators are moulded into the tyre design. They allow regrooving tools to be set to the optimum depth.

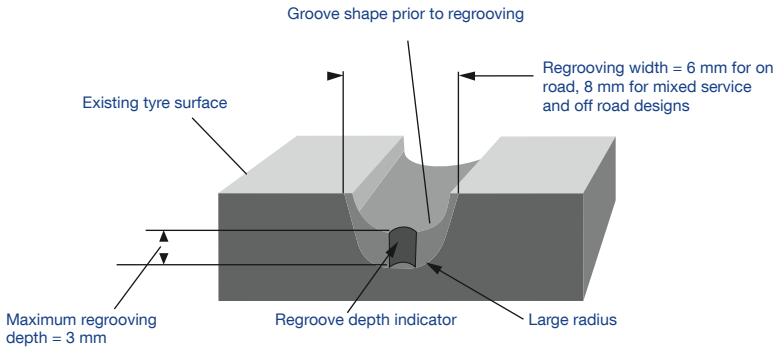

# Marathon

## Marathon LHS II 22.5

New tyre tread

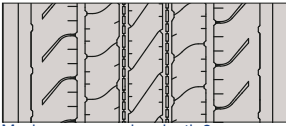

80% worn

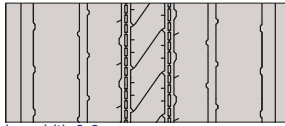

Regrooved tyre

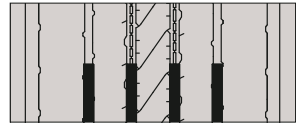

Maximum regrooving depth 3 mm, regrooving width 6-8 mm.

## Marathon LHS II 65, 55 and 50 series

New tyre tread

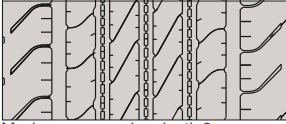

80% worn



Regrooved tyre



Maximum regrooving depth 3 mm, regrooving width 6-8 mm.

## Marathon LHS LR8

New tyre tread

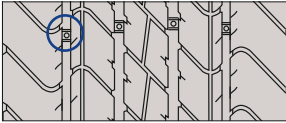

80% worn

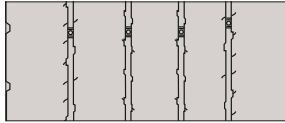

Regrooved tyre

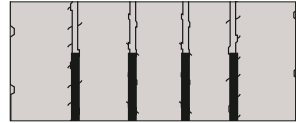

Maximum regrooving depth 3 mm, regrooving width 6 mm.

O = Regrooving depth indicators

## Marathon LHD II 22.5

New tyre tread



80% worn

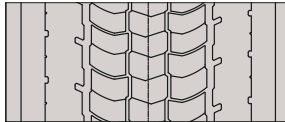

Regrooved tyre



Maximum regrooving depth 3 mm, regrooving width 6-8 mm.

## Marathon LHD II 265/55R19.5

New tyre tread

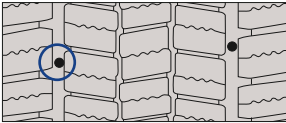

80% worn

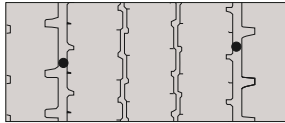

Regrooved tyre



Maximum regrooving depth 3 mm, regrooving width 6 mm.

O = Regrooving depth indicators

## Marathon LHD Super Single 495/45R22.5

New tyre tread



80% worn

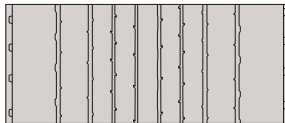

Regrooved tyre



Maximum regrooving depth 3 mm, regrooving width 6 mm.

## Marathon LHT+ 435/50R19.5

New tyre tread



80% worn

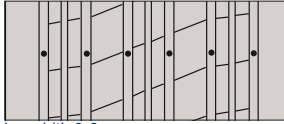

Maximum regrooving depth 3 mm, regrooving width 6-8 mm.

Regrooved tyre



O = Regrooving depth indicators

## Marathon LHT 65 and 55-SERIES

New tyre tread

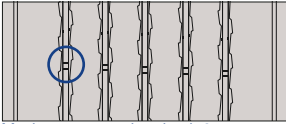

80% worn

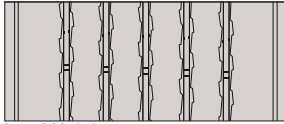

Maximum regrooving depth 3 mm, regrooving width 6-8 mm.

Regrooved tyre



O = Regrooving depth indicators

## Marathon LHT+ 455/40R22.5

New tyre tread

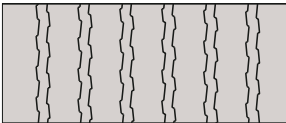

80% worn



Maximum regrooving depth 3 mm, regrooving width 6-8 mm.

Regrooved tyre

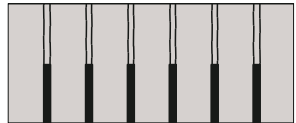

## Marathon LHT LPT

New tyre tread

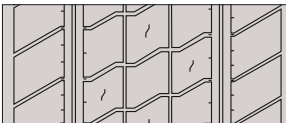

80% worn



Maximum regrooving depth 3 mm, regrooving width 6 mm.

Regrooved tyre



## Marathon LHT 265/55R19.5

New tyre tread



80% worn

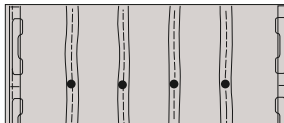

Maximum regrooving depth 3 mm, regrooving width 6-8 mm.

Regrooved tyre



O = Regrooving depth indicators

# Regional

## Regional RHS II 22.5

New tyre tread

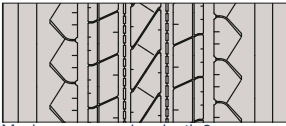

80% worn

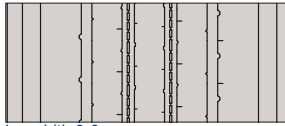

Regrooved tyre

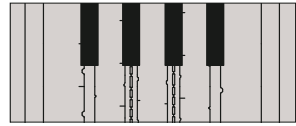

Maximum regrooving depth 3 mm, regrooving width 6-8 mm.

## Regional RHS II 17.5 and 19.5

New tyre tread

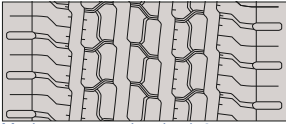

80% worn

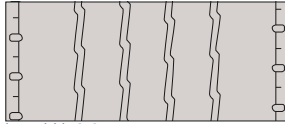

Regrooved tyre



Maximum regrooving depth 3 mm, regrooving width 6-8 mm.

## Regional RHD II 22.5

New tyre tread

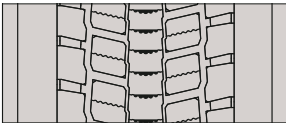

80% worn



Regrooved tyre

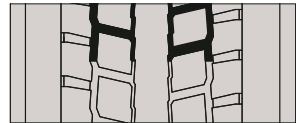

Maximum regrooving depth 3 mm, regrooving width 6-8 mm.

## Regional RHD II 17.5 and 19.5

New tyre tread

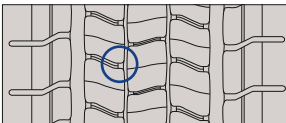

80% worn

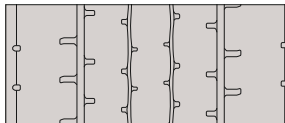

Regrooved tyre



Maximum regrooving depth 3 mm, regrooving width 6 mm.

O = Regrooving depth indicators

## Regional RHT

New tyre tread

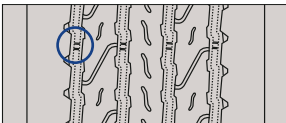

80% worn

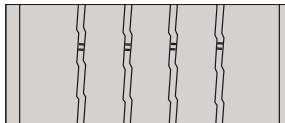

Regrooved tyre

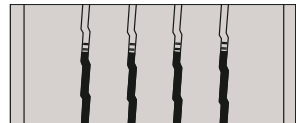

Maximum regrooving depth 3 mm, regrooving width 6-8 mm.

O = Regrooving depth indicators

## Regional RHT LPT

New tyre tread

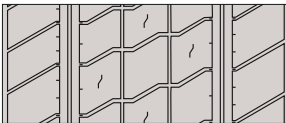

80% worn

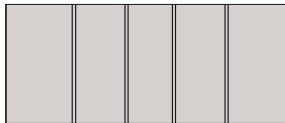

Regrooved tyre



Maximum regrooving depth 3 mm, regrooving width 6 mm.



# Omnitrac

## Omnitrac MSS 4-rib

New tyre tread



Maximum regrooving depth 3 mm, regrooving width 6 mm.

80% worn

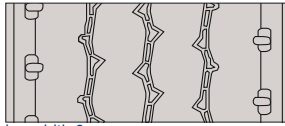

Regrooved tyre



O = Regrooving depth indicators

## Omnitrac MSS 5-rib

New tyre tread



Maximum regrooving depth 3 mm, regrooving width 6 mm.

80% worn



Regrooved tyre



O = Regrooving depth indicators

## Omnitrac MSS 75 and 90 series

New tyre tread

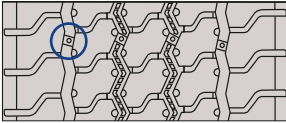

Maximum regrooving depth 3 mm, regrooving width 8 mm.

80% worn

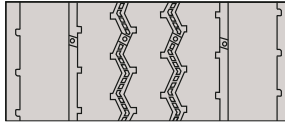

Regrooved tyre

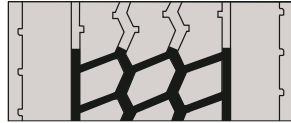

O = Regrooving depth indicators

## Omnitrac MSD

New tyre tread



Maximum regrooving depth 3 mm, regrooving width 6-8 mm longitudinal, 8-10 mm radial.

80% worn

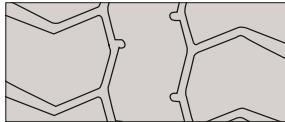

Regrooved tyre



## Omnitrac MST

New tyre tread

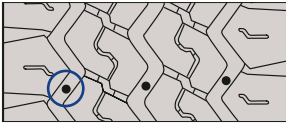

Maximum regrooving depth 3 mm, regrooving width 8 mm.

80% worn

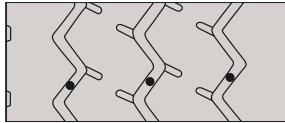

Regrooved tyre

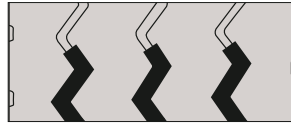

O = Regrooving depth indicators

# Offroad

## Offroad ORD

New tyre tread



80% worn



Regrooved tyre



Maximum regrooving depth 3 mm, regrooving width 8-10 mm.

## Offroad ORD 90 and 85 series

New tyre tread

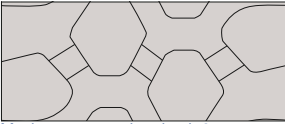

80% worn

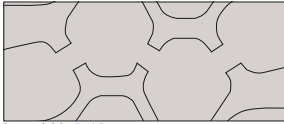

Regrooved tyre

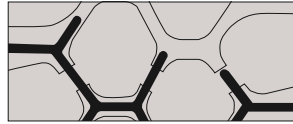

Maximum regrooving depth 3 mm, regrooving width 8-10 mm.

## Offroad ORD 14.00R20

New tyre tread

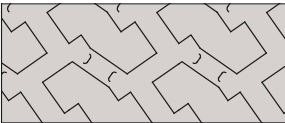

80% worn

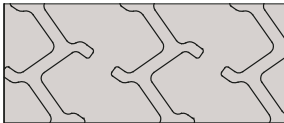

Regrooved tyre



Maximum regrooving depth 3 mm, regrooving width 8-10 mm.



# Urban

## UrbanMax MCA

New tyre tread

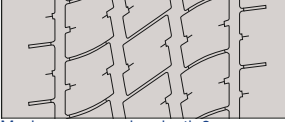

80% worn

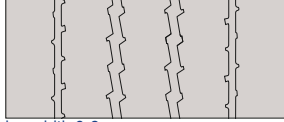

Regrooved tyre



Maximum regrooving depth 3 mm, regrooving width 6-8 mm.

## UrbanMax MCD Traction

New tyre tread

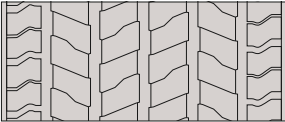

80% worn

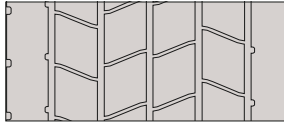

Regrooved tyre



Maximum regrooving depth 3 mm, regrooving width 6-8 mm.

## MCD Super Single

New tyre tread



80% worn

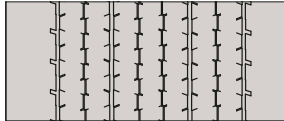

Regrooved tyre

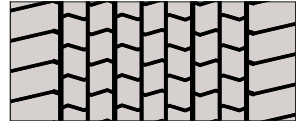

Maximum regrooving depth 3 mm, regrooving width 6-8 mm.





# UltraGrip

## UltraGrip WTS

New tyre tread

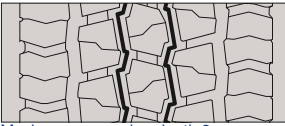

80% worn

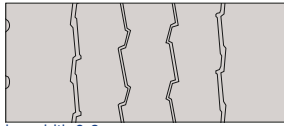

Regrooved tyre

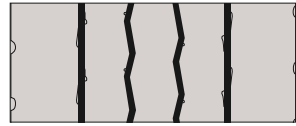

Maximum regrooving depth 3 mm, regrooving width 6-8 mm.

## UltraGrip WTS 6-rib

New tyre tread



80% worn

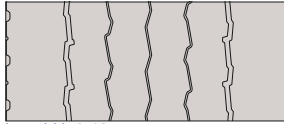

Regrooved tyre



Maximum regrooving depth 3 mm, regrooving width 6-10 mm.

## UltraGrip WTD

New tyre tread

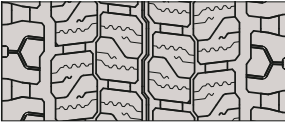

80% worn

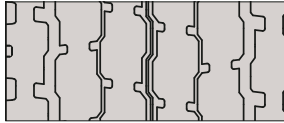

Regrooved tyre



Maximum regrooving depth 3 mm, regrooving width 6-10 mm.



---

# Tyre Technology

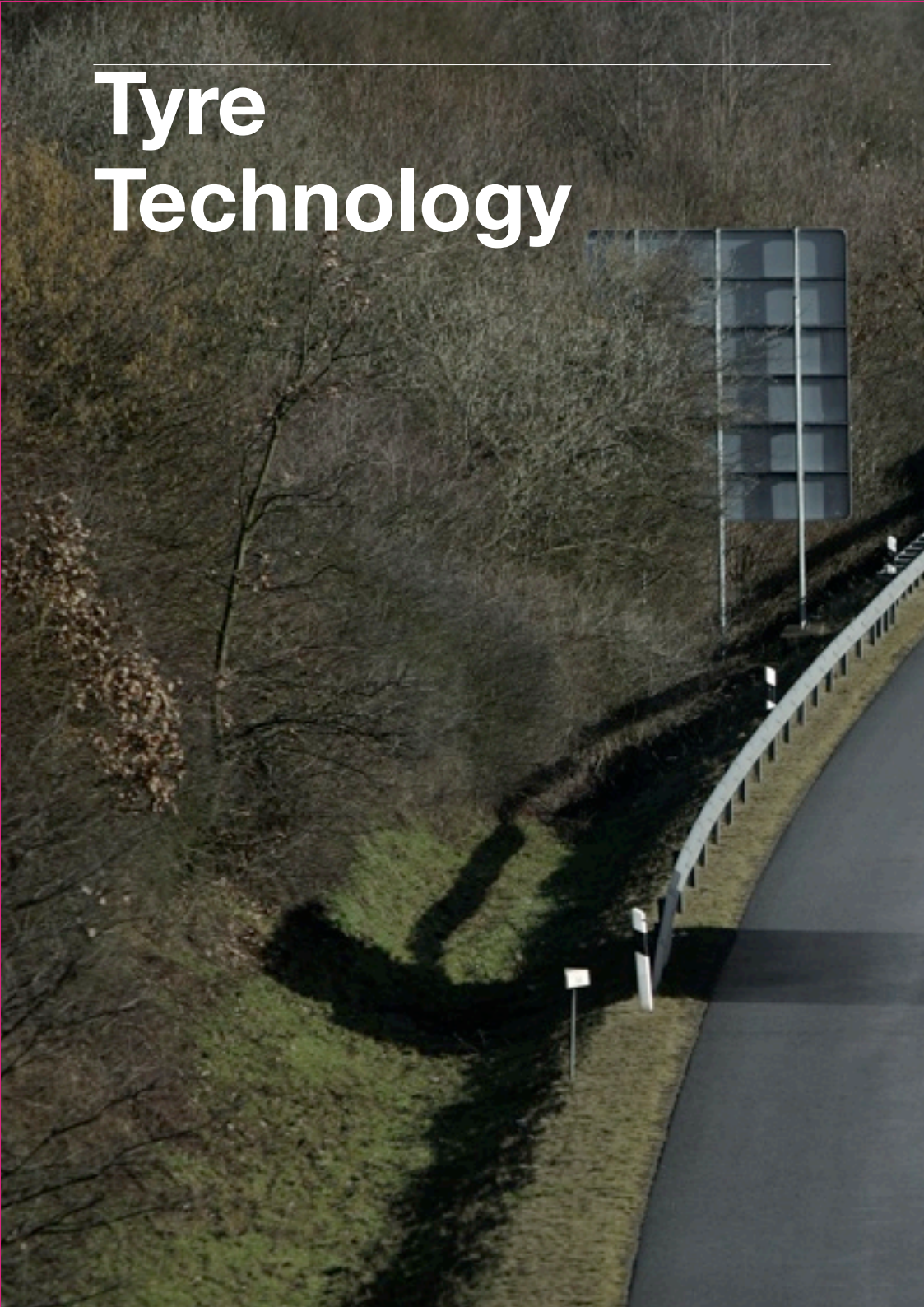



# Tyre construction and tyre terminology

Truck tyres are a high value investment whose performance potential can be dramatically influenced by a multitude of service parameters - which can be globally identified as operating and maintenance conditions. In other words, the true cost per kilometre is not only a function of the tyre quality and price, but is primarily a direct consequence of the actual running conditions of the tyre. In order to be able to optimise these conditions, it is essential to first of all be familiar with the construction characteristics of a tyre and to understand its mechanical properties.

It will also be desirable to have a basic knowledge of vehicle dynamics and to recognise the importance of environmental factors such as road design and ambient temperature.

This brochure is designed to convey these elementary rules and guidelines and to therefore help minimise fleet operating expenses. For further clarifications and updated facts and figures, please consult with your Goodyear truck tyre specialist.

## Tyre construction (Figure 1)

The commercially available tyre is a composite product, made up from rubber compounds and textile, steel synthetic reinforcements. The major components of the Goodyear radial ply, steel carcass and belt tyre are described below.

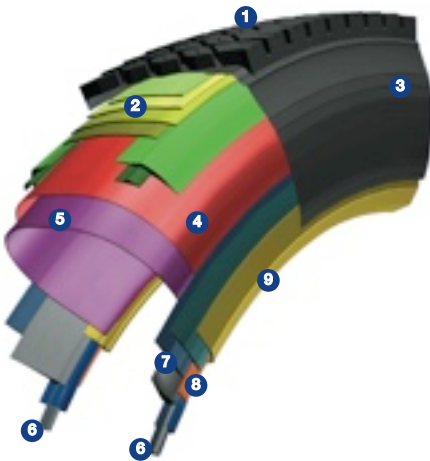

Tube-Type

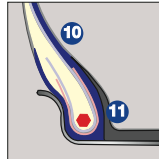

### Features

- 1 Tread
- 2 Belt Package
- 3 Sidewall
- 4 Ply
- 5 Innerliner
- 6 Bead Bundle
- 7 Apexes
- 8 Chipper
- 9 Chafer
- 10 Tube\*
- 11 Flap\*

\* Only applicable to tube type tyres

---

## Tyre terminology

---

- **Tread** - Provides primarily traction and wear and protects the carcass underneath.
- **Belt** - Multiple, low angle, steel cord layers provide strength to the tyre, stabilise the tread and prevent penetrations into the carcass.
- **Sidewall** - Provides protection for the ply and withstands flexing and weathering.
- **Ply** - The radial (90°) ply transmits all load, braking and steering forces between the wheel and the road and withstands the burst loads of the tyre under operating pressure.
- **Innerliner** - A layer of rubber in tubeless tyres specially compounded to prevent loss of air.
- **Bead bundle** - The steel bead bundle properly seats and seals the tyre on the rim and maintains it in position.
- **Apex** - Rubber filler in the bead and lower sidewall area to provide progressive transition from the stiff bead area into the flexible sidewall.
- **Chafer** - A layer of hard rubber that resists erosion of the bead zone by the rim flange.
- **Tube\*** - A separate air chamber, compounded to prevent loss of air, inserted into tube-type tyres.
- **Flap\*** - A rubber band placed between tube and rim. Protects the tube from chafing and prevents damage to the tube by the rim.

\*Only applicable to tube type tyres.

---

## Tyre dimension definitions

---

Tyre companies throughout the world are members of regional tyre manufacturers associations (ETRTO for Europe), which establish tyre dimensions and tolerances, load carrying capacities and inflation pressures for the different tyre categories and sizes. The basic tyre and rim dimension nomenclature is explained below.

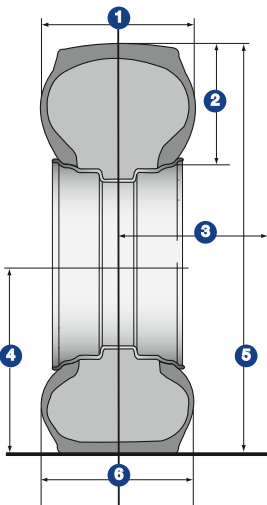

- 1 **Outside Diameter (OD)** - The diameter of an unloaded tyre, mounted on its recommended rim and inflated to recommended pressure.
- 2 **Section Width (SD)** - The width of the inflated tyre section, excluding any lettering or decoration.
- 3 **Section Height (SH)** - The distance from the bead seat to the outer tread contour of the inflated tyre at centreline.
- 4 **Static Loaded Radius (SLR)** - The standing height from the road surface to the axle centre under nominal tyre load/inflation conditions.
- 5 **Loaded Section Width (LSW)** - The width of the loaded cross-section.
- 6 **Minimum Dual Spacing** - The minimum recommended distance between centrelines of dual mounted tyres to avoid kissing in the flex area.

**Aspect Ratio** - The section height (SH) expressed as a percentage of the section width (SD).

---

# Tyre markings

---

## Size markings

---

There are various forms of tyre size marking and these differ in order to differentiate between tyre types. The size markings should be treated the same as a part number on a vehicle, so the motorist should ensure that the tyres on his vehicle carry the precise markings indicated in the vehicle handbook or are an approved alternative fitment.

---

## Service description

---

In accordance with the European regulation (ECE-R54), all tyres intended for commercial vehicles will be marked with a “Service Description” located near to the tyre size marking. This consists of a code which indicates operating limits of load and speed and includes a “load index” for single and dual tyre fitment and a “speed symbol” (e.g. 156/150 L).

An additional marking may be used to show the corresponding tyre loads for an alternative higher speed or for an alternative higher load. This additional marking will be placed in a circle.

---

## Size definitions

---

Listed below are the size designations that are being used on truck tyres. With each size is an explanation of what each component describes.

<b>12</b> Section width in inches	<b>/</b>		<b>R</b> R-radial	<b>22.5</b> Rim diameter in inches	<b>152/148</b> Load index (single/dual mounted)	<b>M</b> Speed symbol
---	----------	--	----------------------	--	---	-----------------------------

<b>295</b> Section width in inches	<b>/</b>	<b>80</b> Aspect ratio	<b>R</b> R-radial	<b>22.5</b> Rim diameter in inches	<b>152/148</b> Load index (single/dual mounted)	<b>M</b> Speed symbol
--	----------	------------------------------	----------------------	--	---	-----------------------------

<b>365</b> Section width in inches	<b>/</b>	<b>80</b> Aspect ratio	<b>R</b> R-radial	<b>20.0</b> Rim diameter in inches	<b>160</b> Load index (single/dual mounted)	<b>J</b> Speed symbol
--	----------	------------------------------	----------------------	--	---	-----------------------------

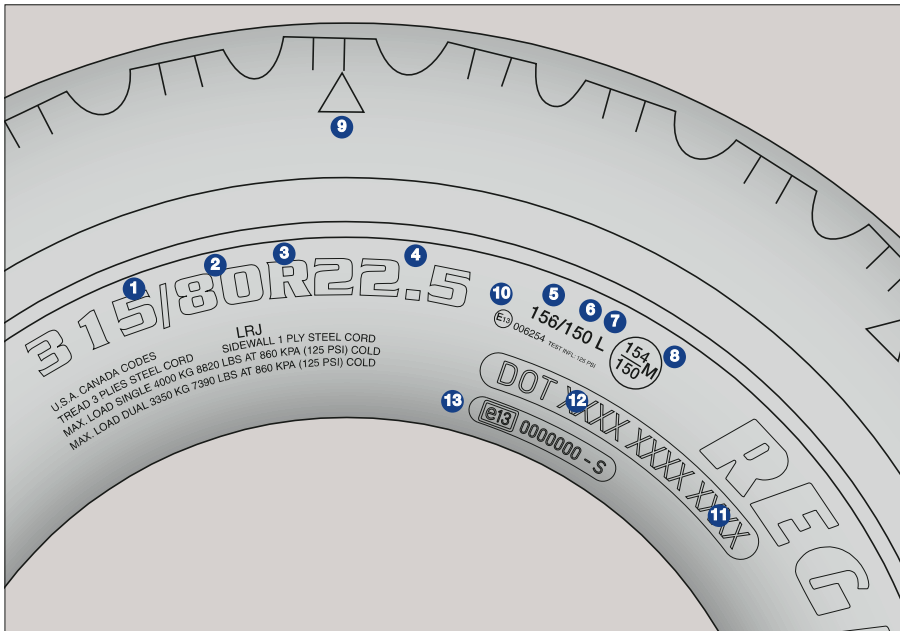

The position of the major tyre markings are as shown;

- 1 Tyre Section width (mm or inches)
- 2 Aspect ratio S.H./S.W.
- 3 Radial construction (R=Radial)
- 4 Rim Diameter (inches)
- 5 Load Index (Max. load per tyre - single tyre)
- 6 Load Index (Max. load per tyre - dual mounted)
- 7 Speed Symbol
- 8 Alternative load indices when used with alternative speed
- 9 TWI - Tread Wear Indicator
- 10 ECE Homologation number
- 11 Date code (week, year)
- 12 DOT Manufacturing Code
- 13 Noise number - indicates that the tyre conforms to ECE noise regulations

#### USA and Canada

In accordance with US Safety Regulation MVSS 109 for Car tyres, and 119 for Truck tyres, the maximum load of the tyre in pounds (LBS) and its corresponding air pressure in pounds per square inch (PSI) must be shown on the tyre.

Additionally, the tyre must be marked D.O.T. (Department of Transportation) to insure that it conforms to all valid regulations in these countries.

# Load Index and Speed Symbol

These parameters are established by ETRTO and are the two most important service factors determining tyre performance.

Load indices and speed symbols are shown on both tyre sidewalls. Example: 149/145 L. The first number denotes the tyre load carrying capacity in SINGLE application, while the second number refers to DUAL fitment. The letter “L” defines the maximum speed limit. Unmarked Radial tyres are allowed up to a speed of 110 km/h. (Bias ply tyres are confined to 100 km/h).

Retreaded tyres can be run up to a maximum speed of 110 km/h, unless they are marked otherwise.

Special purpose tyres, for specific heavy duty applications must have the respective speed limitations identified on the sidewall.

The speed and load service identifications below are required by the European ECE-R54 regulation. The scale below shows the relationship between the Load Index (LI) and actual load values in kilograms (kg).

## Load Index

LI	kg	LI	kg	LI	kg	LI	kg	LI	kg	LI	kg
50	190	70	335	90	600	110	1060	130	1900	150	3350
51	195	71	345	91	615	111	1090	131	1950	151	3450
52	200	72	355	92	630	112	1120	132	2000	152	3550
53	206	73	365	93	650	113	1150	133	2060	153	3650
54	212	74	375	94	670	114	1180	134	2120	154	3750
55	218	75	387	95	690	115	1215	135	2180	155	3875
56	224	76	400	96	710	116	1250	136	2240	156	4000
57	230	77	412	97	730	117	1285	137	2300	157	4125
58	236	78	425	98	750	118	1320	138	2360	158	4250
59	243	79	437	99	775	119	1360	139	2430	159	4375
60	250	80	450	100	800	120	1400	140	2500	160	4500
61	257	81	462	101	825	121	1450	141	2575	161	4625
62	265	82	475	102	850	122	1500	142	2650	162	4750
63	272	83	487	103	875	123	1550	143	2725	163	4875
64	280	84	500	104	900	124	1600	144	2800	164	5000
65	290	85	515	105	925	125	1650	145	2900	165	5150
66	300	86	530	106	950	126	1700	146	3000	166	5300
67	307	87	545	107	975	127	1750	147	3075	167	5450
68	315	88	560	108	1000	128	1800	148	3150	168	5600
69	325	89	580	109	1030	129	1850	149	3250	169	5800

The LOAD INDEX denotes the maximum load a given tyre can carry at the maximum speed as indicated by the speed symbol.

## Speed Symbol

Speed symbol	Speed (km/h)
E	70
F	80
G	90
J	100
K	110
L	120
M	130
N	140

The SPEED SYMBOL denotes the maximum speed at which a given tyre can carry the load indicated by the load index.



# Interaction of Load and Speed

## Load Capacity Variations (%) as a function of Speed

Below information is based on the “European Tire and Rim Technical Organization - Standards Manual” - Load Variation with Speed section.

### Variations in Load Carrying Capacity with Speed (%)

Speed km/h	F 80 km/h	G 90 km/h	J 100 km/h	K 110 km/h	L 120 km/h	M 130 km/h	Inflation Pressure (%)* Compensation
Static	+150	+150	<b>+150</b>	+150	+150	+150	+40
5	+110	+110	<b>+110</b>	+110	+110	+110	+40
10	+80	+80	<b>+80</b>	+80	+80	+80	+30
15	+65	+65	<b>+65</b>	+65	+65	+65	+25
20	+50	+50	<b>+50</b>	+50	+50	+50	+21
25	+35	+35	<b>+35</b>	+35	+35	+35	+17
30	+25	+25	<b>+25</b>	+25	+25	+25	+13
35	+19	+19	<b>+19</b>	+19	+19	+19	+11
40	+15	+15	<b>+15</b>	+15	+15	+15	+10
45	+13	+13	<b>+13</b>	+13	+13	+13	+9
50	+12	+12	<b>+12</b>	+12	+12	+12	+8
55	+11	+11	<b>+11</b>	+11	+11	+11	+7
60	+10	+10	<b>+10</b>	+10	+10	+10	+6
65	+7.5	+8.5	<b>+8.5</b>	+8.5	+8.5	+8.5	+4
70	+5	+7	<b>+7</b>	+7	+7	+7	+2
75	+2.5	+5.5	<b>+5.5</b>	+5.5	+5.5	+5.5	+1
80	<b>0</b>	+4	<b>+4</b>	+4	+4	+4	0
85		2	<b>+3</b>	+3	+3	+3	0
90		<b>0</b>	<b>+2</b>	+2	+2	+2	0
95			<b>+1</b>	+1	+1	+1	0
100			<b>0</b>	0	0	0	0
105				0	0	0	0
110				<b>0</b>	0	0	0
115					0	0	0
120					<b>0</b>	0	0
125						0	0
130						<b>0</b>	<b>0</b>

NOTES: Increment to be applied in the absence of any specific agreement with the tyre manufacturer. These increments do only apply to the “nominal” load/speed indices.

## Additional load/speed markings

The tyre manufacturer has the possibility to add to the “nominal” load/speed indices an additional load/speed index with different load index and different speed index. This additional load/speed index is circled.

For other load benefits due to maximum speed variations please consult the table and notes in the “Interaction of Load and Speed” section.

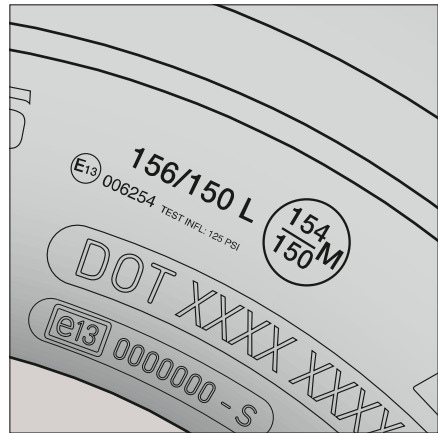

NOTES: ETRTO tables apply only to nominal LI/SI marking.

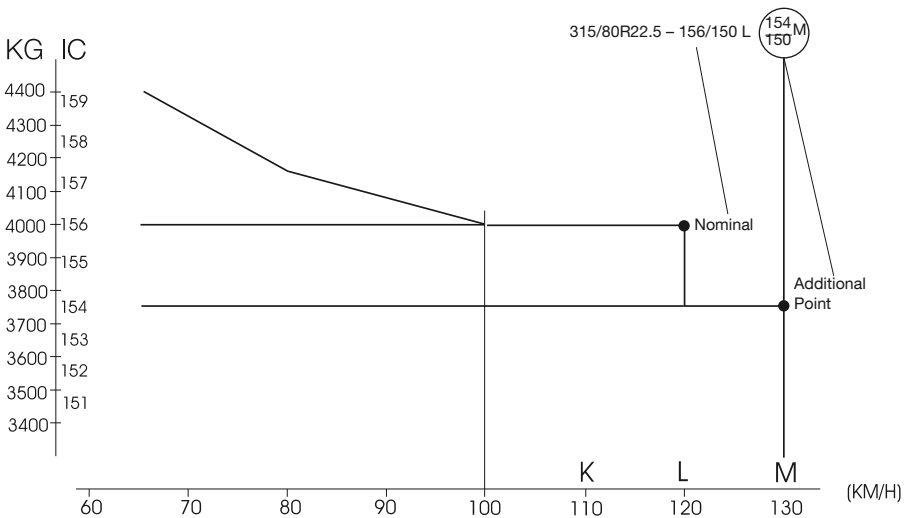

---

## Notes concerning “Variations in load capacity with speed (%)”

---

On the basis of the specific conditions of use of the buses designed for urban or sub-urban services and irrespective of their actual maximum speed capability, the following bonus loads apply:

- For the application being considered, “SPEED” means:

*either* the maximum speed capability of the motor vehicle  
*or* any overriding national requirement/legislation for the type of motor vehicle  
*or*, in case of “special applications”, the specific conditions of use.

- The load carrying capacity of tyres in dual fitments is twice the load carrying capacity in single up to 40 km/h. Bonus loads will not be permitted for speeds of 40 km/h and above if the wheel axles are rigidly fixed to the body of vehicle.
- Bonus loads are not applicable for trailers and semi-trailers at speeds over 65 km/h.

### • General definitions

Buses (Category M3 vehicles in the EU Directive) are subdivided into three classes depending on the intended type of use. Category M3 vehicles, for the carriage of passengers, have more than eight seats in addition to the driver's seat and exceed 5 tonnes in overall weight.

**Class I** - Urban-bus or City bus - foreseen for urban use with frequent stops, these vehicles have spaces for standing passengers and allow movements of passengers.

**Class II** - Sub-urban bus or Interurban bus - foreseen for passenger transport within a given district, these vehicles have no specific spaces for standing passengers, but allow them to keep standing in the gangway for some distances during the trip.

**Class III** - Touring coach - These vehicles mainly foreseen for long distances, are conceived for transportation of sitting passengers only.

On the basis of the specific conditions of use of the buses designed for urban or sub-urban services and irrespective of their actual maximum speed capability, the following bonus loads apply:

**Class I:** + 15% of the load indices marked on the tyre, when the average speed does not exceed 40 km/h.

**Class II:** + 10% of the load indices marked on the tyre, when the operating speed is restricted to 60 km/h.

**Class III:** no bonus load Class

- For the equipment of special public service vehicles in urban and suburban applications (for instance road sweepers, fire tenders, etc.), on the basis of specific conditions of use and irrespective of the actual maximum speed capabilities of the vehicle, a bonus load of 10% applies with respect to the load indices marked on the tyre.
- In any case, it is recommended to avoid the maximum permissible load capacity if the resulting inflation pressure is higher than 1000 kPa. In that case, the load capacity shall be reduced accordingly.
- It is imperative to consult Rim/Wheel Manufacturers for the choice of rims and wheels suitable for the load carrying capacities and the inflation pressures required for applications at speeds of 40 km/h and below.

# Rims and Wheels

For truck tyres, there are essentially 3 basic rim types available on the market:

- one-piece tubeless drop centre rims
- multi-piece tube-type flat base rims
- multi-piece tubeless flat base rims

## One-piece tubeless drop centre

5° Drop Centre Rim - (13", 14", 17" etc...) symmetric and asymmetric rims for standard and low section light truck (C) tyres.

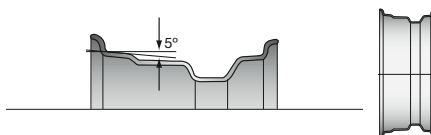

15° Drop Centre Rim - (17.5", 19.5", 22.5" etc...) rims for standard and wide section (Low Aspect Ratio, Super Single) tyres.

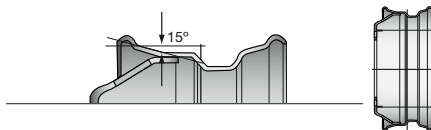

## Two and four-piece tube-type flat base

(Mainly 20") rims for high aspect ratio tyres. It will be important to avoid interchanging of parts from both systems.

NOTE: Each system is usually identified accordingly (stamped 2P or 4P).



## Two-piece tube-type flat base



Combination Side Ring

## Four-piece tube-type flat base

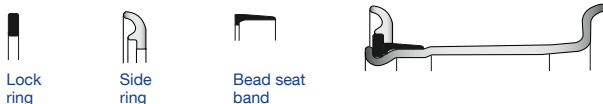

Lock ring

Side ring

Bead seat band

## Four-piece tube-type flat base



Lock ring

Side ring

Bead seat band

(20") rims for mainly 80-series tyres. They require a new sealing gasket for each new tyre.

Complete wheel details are shown below:

- 1 – Drop centre
- 2 – Disc
- 3 – Rim/disc junction
- 4 – Hub contact face
- 5 – Pitch (bolt) circle diameter
- 6 – Offset
- 7 – Centre hole diameter
- 8 – Stud hole diameter
- 9 – Rim flange
- 10 – Taper
- 11 – Rim Width
- 12 – Rim flange height
- 13 – Rim flange width
- 14 – Rim flange radius
- 15 – Valve hole
- 16 – Ball tape

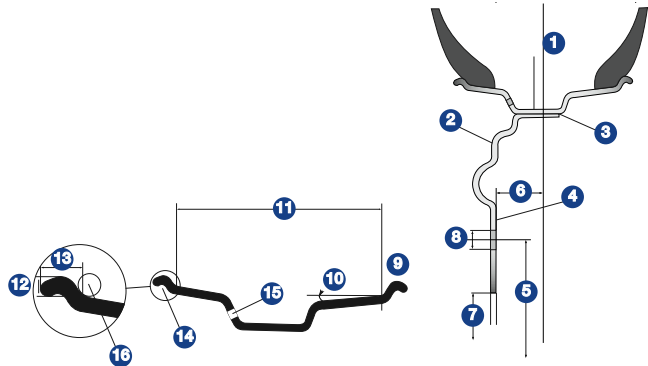

NOTE: Rim diameters can only be accurately measured by means of a special ball tape.

All wheels have a given offset (O) which does not only provide for the necessary brake drum space, but which also determines track width, kingpin offset, handling characteristics and wheel bearing load. On dual assemblies, it also influences the dual spacing.

Tyre fitters and mechanics must therefore pay attention that:

- specific vehicles are fitted with the correct offset wheels.
- wheels with different offsets are not mixed up on the same axle.

Wheel offsets can be positive, negative or zero. The offset is defined as the distance from the wheel centre to the inside face of the disc (against the hub) and is called positive whenever this inside face is located outside of the centreline, negative when located inside, zero when matching the centreline exactly.

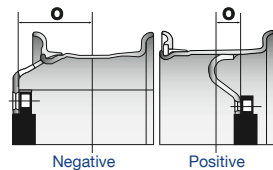

As a general maintenance rule, assembling and disassembling of multi-piece rims should only be done with specially designed tools. Also, for 1-piece tubeless rims, proper tooling is essential, since it will otherwise be extremely difficult or even impossible to mount such tyres safely and without bead area damage.

For demountable 1- or multiple-piece spoke-type wheels, the following additional precautions should be taken:

- Contact surfaces between rim and star should not be painted to guarantee perfected centring.
- Bolts should be tightened clockwise (not crosswise) - without exceeding the recommended maximum torque given by the vehicle manufacturer.
- Bolts and clamps should be re-checked at 50-100 km after wheel fitment and re-tightened if necessary.
- In case of dual mounting, the spacer ring should be pre-centred over the centring cams (placed on spokeheads).

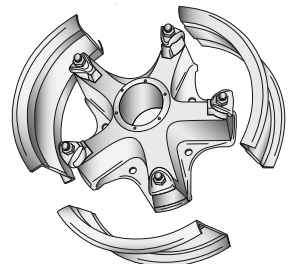

---

# Tubes and Flaps

---

Only use “Radial” marked tubes and flaps in Radial Tyres. Preferably fit a new tube and a new flap when mounting a new tyre. Due to their inherent construction, Radial Tyres impose far greater local stresses on Inner tubes than do Bias Tyres. “Radial” marked Tubes are specially compounded to withstand these stresses and their use in Radial Tyres is mandatory. “Radial” marked Tubes may also be used in Bias Tyres, but in this application, unmarked Bias Tubes are perfectly satisfactory.

The higher stresses in Radial Tyres render the tube more susceptible to Flap Edge Cutting, and the use of “Radial” marked flaps, specially compounded such that they will not harden excessively in service is mandatory.

---

## Tubes

---

Tubes are designed within well defined limits of Radial and Total Stretch. A tube too large will be liable to buckling, and to early failure. A tube too small will be stretched excessively, leading to reduced rub resistance, and poorer air retention. In an emergency, a small tube is better than a large tube, since the failure mode is less likely to be catastrophic.

In case of necessity, a tube may be reused, if,

- There is no apparent damage and
- If the tube has not grown excessively during the first life. It is suggested that for a tube to be reused, a residual radial stretch of at least 15% is required.

NOTE: The fitment of tubes to “tubeless” tyres is not recommended.

---

## Flaps

---

The flap is designed to:

- Protect the tube from the roughness of the rim.
- To prevent the tube being pinched by the component parts of multi-pieced rims.
- To prevent the tube being pushed through the valve slot.

As a rule we can say that flaps are necessary for any rim which has a valve slot as against a valve hole.

All Drop centre rims including passenger, truck and farm, have a valve hole on the side of the well and require an off centre valve on the tube. They do not require a Flap.

Drop centre truck rims occasionally have the valve hole on centre, but these are normally only fitted with run out tubes in emergency cases which is a practice not endorsed by Goodyear.

All flat base rims with a removable flange have a valve slot extending from the centreline of the rim to the edge. These rims require a flap, and a tube with an on centre valve.

All Semi Drop Centre rims have a short valve slot, which may be on or off centre dependant on the type of rim, and upon the rim manufacturer, and require flaps and tubes with respectively on or off centre valvehole, and tube valve.

---

## Rim slot cover plates

---

Even the best flaps, subjected as they are to high pressure and temperature, (wheel temperatures as high as 200°C have been measured on the inside rear position in City Bus service in Europe) are liable to be pushed through the rim slot in service.

Flaps are designed with fabric, or heavy rubber reinforcement in the valve slot area to overcome this problem, but for critical applications, the use of commercially available rim slot coverplates, or even a large diameter metal washer are recommended. Since the push through, and possible failure occurs next to the bead, rather than around the valve, Bridge plates, are not really effective, and their use in Europe is decreasing.

---

## Medium truck - 20/22/24"

---

Tyre size	Tube	Rim	Flap
9.00R20	9.00R20	6.5	20R6.0
		7.0	20R7.0
		7.5	20R7.0
10.00R20	10.00R20	7.0	20R7.0
		7.5	20R7.0
		8.0	20R8.0
11.00R20	11.00R20	7.5	20R7.0
		8.0	20R8.0
		8.5	20R8.5
12.00R20	12.00R20	8.0	20R8.5
		8.5	20R8.5
		9.0	20R9.5
14.00R20	14.00R20	10.0	20R9.0
11.00R22	11.00R22	7.5	22R8.0
		8.0	22R8.0
		8.5	22R8.5
12.00R24	12.00R24	8.0	24R8.5
		8.5	24R8.5
		9.0	24R9.0

# Valves

Three types of Inner Tube Valve exist in Commercial service:

## Rubber covered valves

Rubber covered valves which may be rigid as for the TR15, or hand bendable as for the TR150.

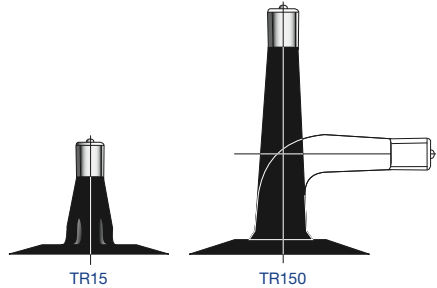

## One-piece metal valves

One-piece metal valves, such as the TR44\* series. These are generally supplied with the required bent form, and may be single, double or triple bent.

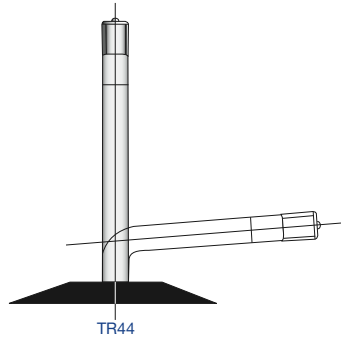

## Two-piece metal valves

European style two-piece metal valves consist of a spud (a short threaded metal tube) vulcanised onto the tube and a pre-bent extension which screws onto the spud, using a rubber washer as the air seal.

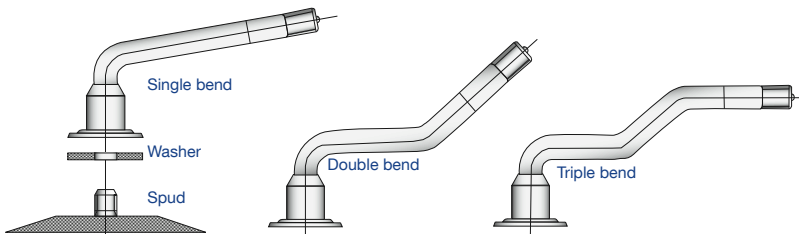



---

## Fitting extension valves

---

Extensions are actually coded in the form V\*-\*\*-\*\*, but to avoid confusion are generally referred to as the designation of the one piece metal valve to which they are equivalent.

The weakest part of the design of the extension type valves is the rubber washer. The washer is compressed when the valve is tightened, and loses its elasticity with age. Rubber washers should never be reused since they harden and take a permanent set. Similarly, extensions should never be backed off to make them line up with the rim slots.

The correct procedure is to wind the extension onto the stem until it just contacts the washer. Take another half turn. Then mount the tyre/tube/flap assembly, and line the extension up with the slot by tightening further.

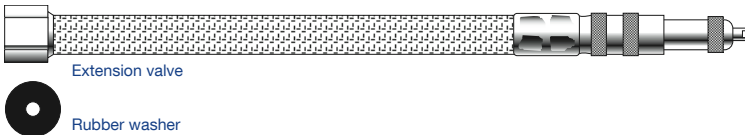

---

## Valve caps

---

Valves must always be fitted with a valve cap.

The valve core is present to allow the internal air pressure to be measured and changed. It is the valve cap which is the primary air seal. Valve caps are always made of metal and have a rubber sealing ring. The plastic dust caps are not suitable for field service.

They are designed to prevent damage to the Tube/Valve/Valve Core during transportation from point of manufacture to point of use.

---

## Valve cores

---

Valve cores are available in two lengths, two temperature ranges, and with either internal or external springs. Fortunately all these cores are interchangeable. It is recommended to use the short core, internal spring, heat resistant type. These are recognisable since the small rubber collar around the core is coloured red.

---

## Conversion from T&RA to reference numbers

---

T&RA	Single	ETRTO Double	Triple
TR75	V3.02.27		
TR76	V3.02.8		
TR78	V3.02.12	V3.04.6	V3.06.5
TR175	V3.02.10	V3.04.4	V3.06.3
TR177	V3.02.9	V3.04.3/10	V3.06.1
TR178	V3.02.14		
TR179	V3.02.15		V3.06.6
TR285			V3.07.1

NOTE: Goodyear primarily manufactures truck tubes with spud/screw on extension type valves.

# The tyre manufacturing process

## Raw Materials



**Textile Industries**  
Early tyre fabric was made from cotton fibre. Today's tyre carcasses are made of fibres such as nylon, rayon, polyester, fibreglass, etc.



**Rubber Plantation**  
Natural rubber is obtained mainly from the Hevea tree in the form of latex which is tapped by cutting through the outer bark of the tree. Liquid latex is collected in little cups and then coagulated to obtain solid rubber. Goodyear operates its own plantations in several parts of the world.



**Chemical Industries**

- Synthetic rubber is derived from crude oil.
- Carbon black, used in rubber compounds to provide increased strength, is produced mainly by burning crude oil in special furnaces.
- Other chemical ingredients such as sulphur, plasticisers, accelerators, antioxidants, etc needed in the tyre manufacturing process, are supplied by various chemical industries.



**Steel Industries**  
High tensile steel wire is used to constitute the bead; the rigid base of a tyre. Cable wire is also used in radial tyres, both for bead and carcass material.

## Fabric Manufacture

Textile fibres are twisted into cords which are woven into fabric with cords running only lengthwise and are held together by threads. The fabric is then impregnated with a special cement to improve adhesion with rubber and is then processed through the exclusive Goodyear 3T unit.

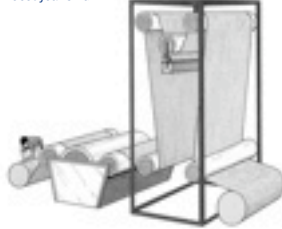

**Fabric Bias Cutter and Sheet Calender**  
The calendered fabric treatment is cut to certain widths and angles to be used as breaker and reinforcement for the body of the tyre. Rubber coatings are applied to the fabric to facilitate adhesion and retention in the finished tyre.

**Banbury Mixer**  
Polymers (natural and synthetic rubber) are mixed by rotors with other ingredients. Mixing of the various ingredients that ultimately constitutes the rubber compound takes place in the Banbury mixer.

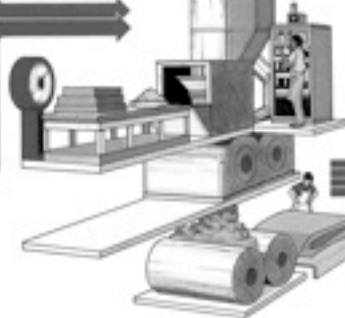

**Extruders**  
Treads, sidewalls and other tyre components are extruded to a specific contour and cut to length in the extruder.



**Wire Calender**  
Individual spools of cable wire are assembled from the creel room into a sheet which is rubber coated on both sides to produce a wire treatment.

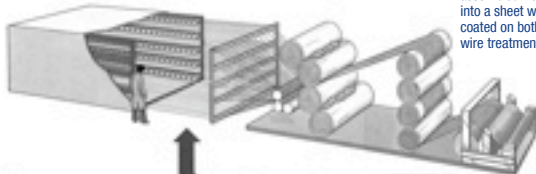

**Bead, Belt, Carcass Wire Manufacture**  
Rough drawing of the rod wire is followed by brass plating and fine drawing. A cord is constituted of several wires by a cabling operation.

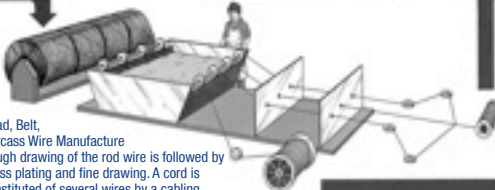

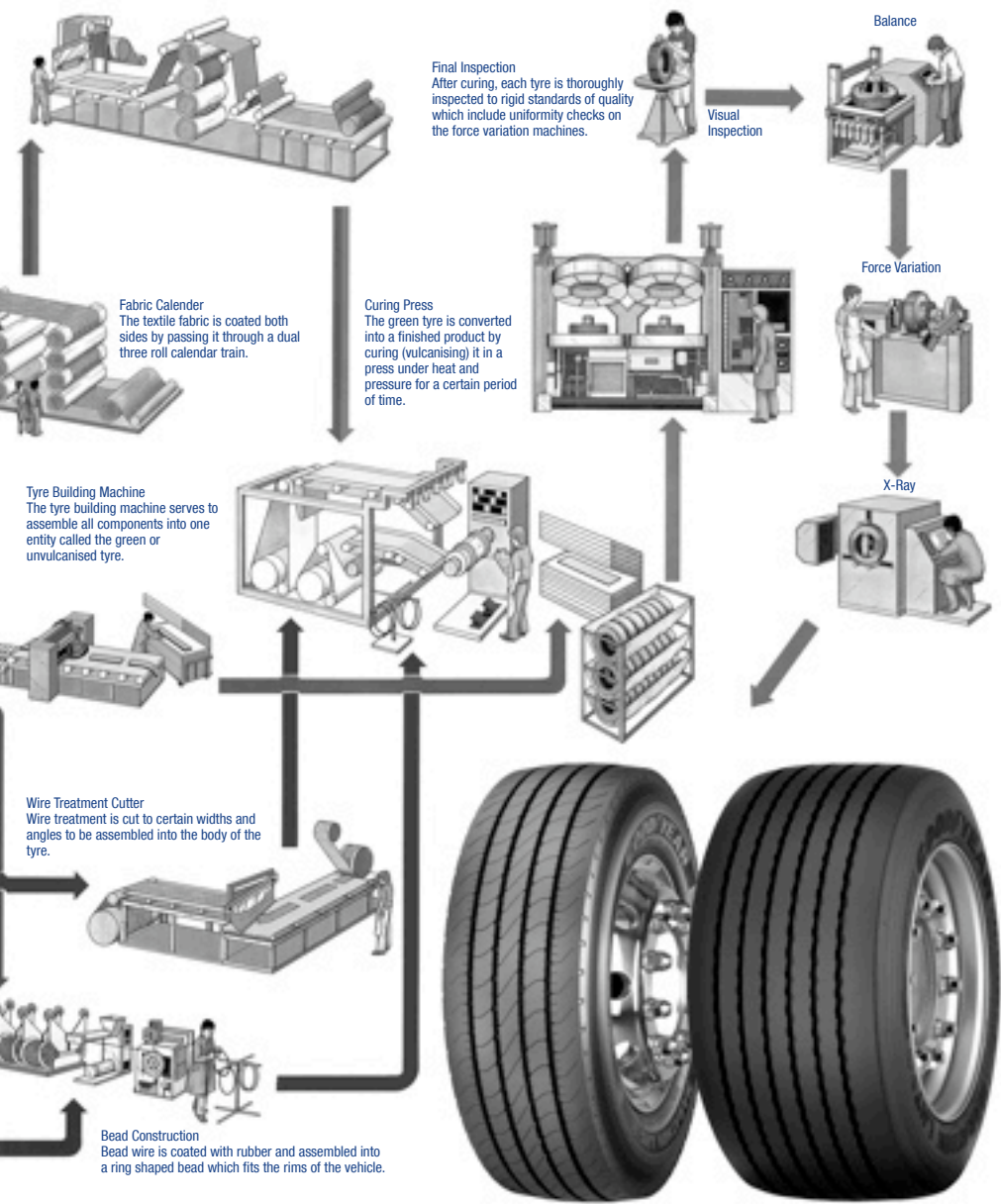

[www.goodyear.eu](http://www.goodyear.eu)

---

**Goodyear Dunlop Tires Operations S.A.**

Av. Gordon Smith  
L-7750 Colmar-Berg

**Telephone**

(352) 8199-1

**Telefax**

(352) 8199 2175

---

Contact your local Goodyear dealer  
for tyre availability

---

Dealer

